



CENTURY SERIES

SP TC GT

OWNER'S MANUAL



Congratulations on your purchase of a Century Series console. All of us at Crest Audio in Paramus, New Jersey, USA, support your decision, knowing your console contains the finest combination of design and manufacture in the industry.

While your new Century Series console is one of the most feature-packed available, great effort has been put into making it simple to operate.

This manual explains the functions of your new console, how they operate and how they relate to each other. If properly cared for, your new console will provide you with trouble-free, sonically accurate mixing clear into the next Century and beyond.

Please keep the following contact information on hand:

Crest Audio Customer Service Dept.
100 Eisenhower Drive
Paramus NJ 07652 USA
TEL 201.909.8700 FAX 201.909.8744
<http://www.crestaudio.com>

Crest Audio Inc.
100 Eisenhower Dr., Paramus NJ 07652 USA
TEL: 201.909.8700 FAX: 201.909.8744
<http://www.crestaudio.com>

Printed in USA

TABLE OF CONTENTS

Feature Overview	2
A brief description of design, features and functions.	
Wiring Conventions	3
Contains diagrams indicating how connectors for Crest consoles are wired.	
Power Supply	4
A brief description of the rack-mountable Century Series consoles power supplies.	
Power Connections	5
A brief description of Crest console power connections.	
System Connections	6
Contains diagrams illustrating conventional system connections.	
SP Input Module	8
Profiles the SP input module.	
TC Input Module	10
Profiles the TC input module.	
GT Input Module	12
Profiles the GT input module.	
GT Stereo Input Module	14
Profiles the GT stereo input module.	
SP/TC Group Module	17
Profiles the SP/TC group module.	
GT Group Module	18
Profiles the GT group module.	
Matrix Module	21
Profiles the matrix module.	
SP/TC Master Section	23
Profiles the SP/TC master section.	
GT Master Section	25
Profiles the SP/TC master section.	
Technical Information	Appendix A
Includes dimensions, specifications, console access details, user options, console block diagram, and rear panel layout.	
Glossary	Appendix B
The specific details of console operation are described here.	
Schematics	Appendix C
Lists available schematics for SP/TC/GT Console Modules & Power Supply	

Feature Overview

The SP / TC / GT features listed below are common to all Century Series Consoles.

- SSM/PMI High quality preamplifiers on balanced microphone/line inputs and on all balanced outputs for uncompromised audio quality and reliability. All IC's within the audio path are socket mounted for easy upgrade or service.
- 48 Volt switchable phantom power on all microphone inputs.
- Optional transformers available on all microphone inputs and on Group, Left/Right, Mono, and Matrix outputs.
- Full Bus assignment section on input and group sections allow for independent assignment to the Mono Clean Bus in addition to the Stereo and sub group sections of the console. The Mono Clean Bus allows for any input or return signal to be assigned to the Mono output without first having to pass through a group.
- Dynamic Signal Present and multiple-sample-point peak indicator LED's are used on all input sections of the console as well as on all primary outputs.
- Mono/Stereo PFL and AFL system. When a stereo module is used, the signal is monitored in stereo while mono modules are monitored in mono. Selected outputs may be monitored in mono or as stereo pairs.
- 8 Auxiliary Mix buses for use as effect and monitor sends. Aux Send circuitry has front panel Pre/Post fader switching. Pre fader signals have internal jumpers to select between a Pre EQ or post EQ signal (Standard) source.
- Standard frame sizes include 24, 32, 40, 44 and 52 position, with a 64 position frame available on special order. Consoles may be ordered as 4 subgroup (8 Module Positions used including Master Section) or 8 subgroup (12 Module Positions used including Master Section) versions.
- Any frame size may be ordered short loaded for later expansion.
- Direct access to Group Mix Bus allows expander mixers to be easily patched into the console.
- Full facility return sections includes Gain Control to handle a wide range of input levels, High and Low frequency EQ, Aux Sends, full Bus assignment section and level, pan, PFL and Mute controls.
- Mute system on input channels is designed to mute both pre- and post-fader signals including those Aux sends used as monitors. When muted, PFL circuitry, Peak and Dynamic Signal Present LED indicators remain fully operational. This is a feature not available on many consoles at any cost.
- External power supply with optional shared load parallel power supply for uncompromised reliability.
- The EQ section includes an EQ IN switch with LED and a 80Hz High Pass filter switch.
- Optional Matrix modules available.
- Optional Stereo Input modules available.
- Comprehensive Talkback section allows access to all primary console outputs. Additional access provided to an external location such as an on-stage monitor mixer system. External signals can also be assigned into the talkback system including Oscillator and Pink Noise source inputs.
- Left/Right summing switches to Aux 1-2 and Aux 3-4 allow for simple setups of overdub mixes by allowing Left/Right signals to be blended with Auxiliary mixes when used in recording applications. In contracting applications, this feature allows these Aux outputs to act as additional distribution amplifiers for the Left/Right signals.

Wiring Conventions

Since the same connectors are used throughout the professional audio industry, it is important to know how the connectors for Crest's Century SP, TC, and GT consoles are wired. The wiring is as follows.

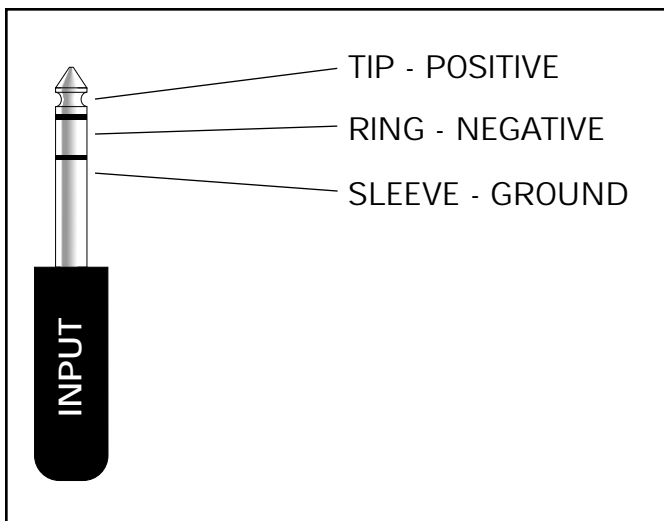
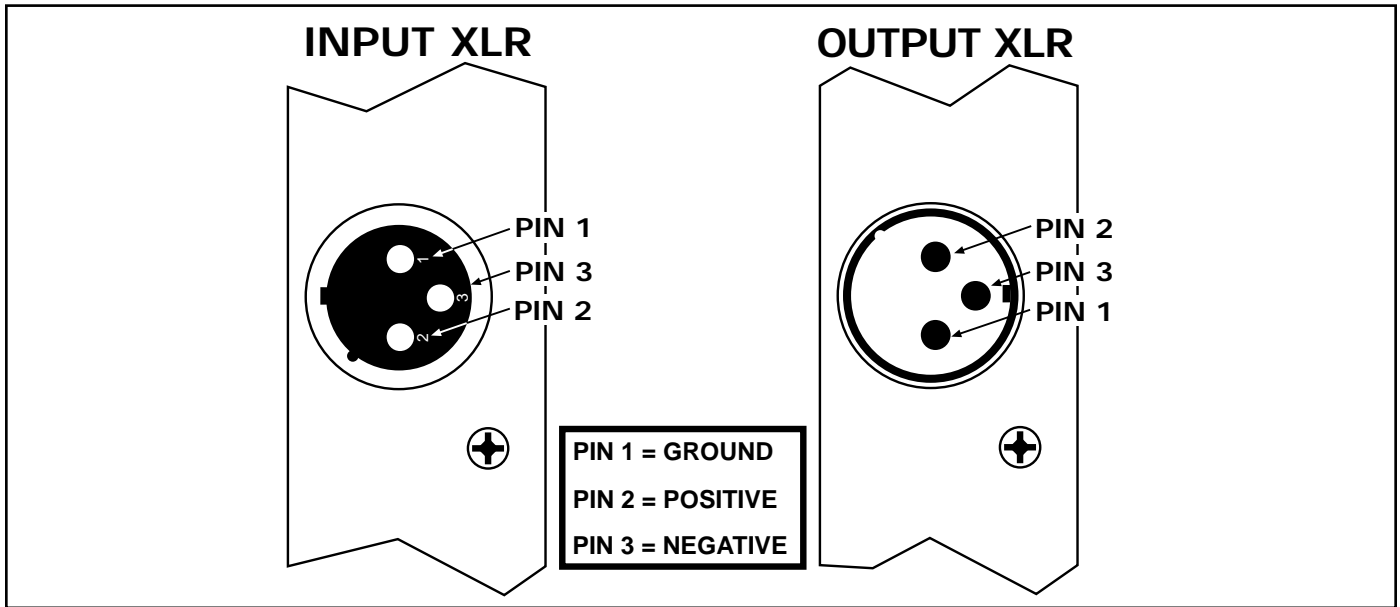

Input Plug Polarities

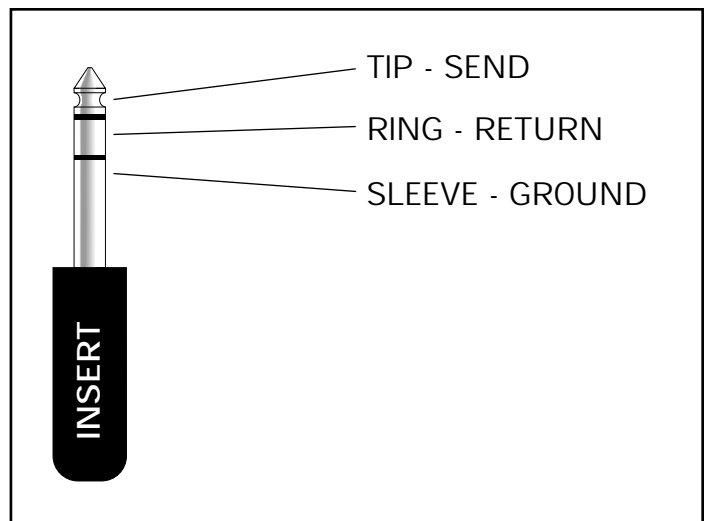

Insert Plug Polarities

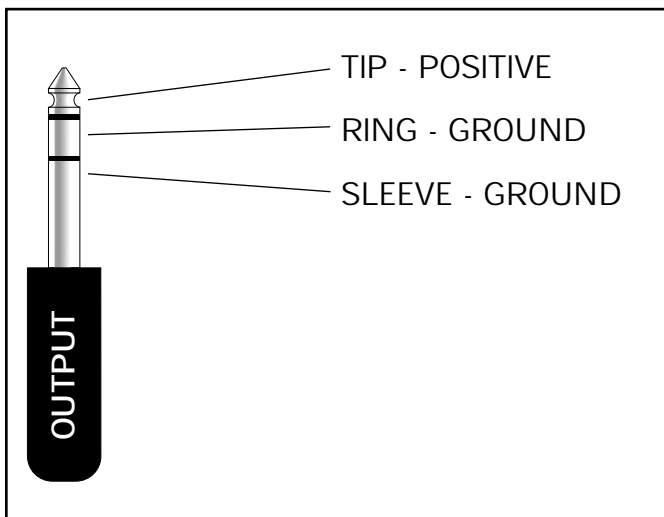

Output Plug Polarity - TRS

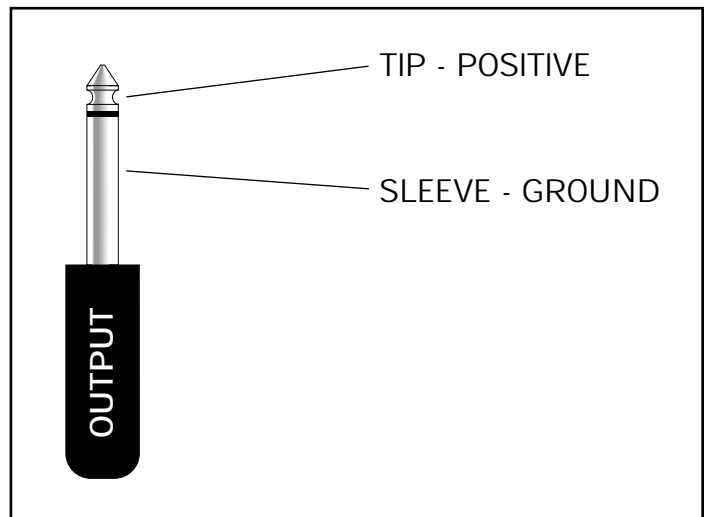

Output Plug Polarity - Tip/Sleeve

Century Series Console Power Supply

Century Series Consoles use a separate rack-mountable power supply which provides the specific voltages used by each console. Crest Audio' Century Series makes use of two different power supplies. The model and frame size of your particular console determines which of the two supplies should be used. SP, TC, and GT consoles use power supplies as follows: Consoles with frame sizes of 24 or 32 modules use supply model XCVA04; consoles with frame sizes of 40, 44, 52, or 64 modules use supply model XCVA06.

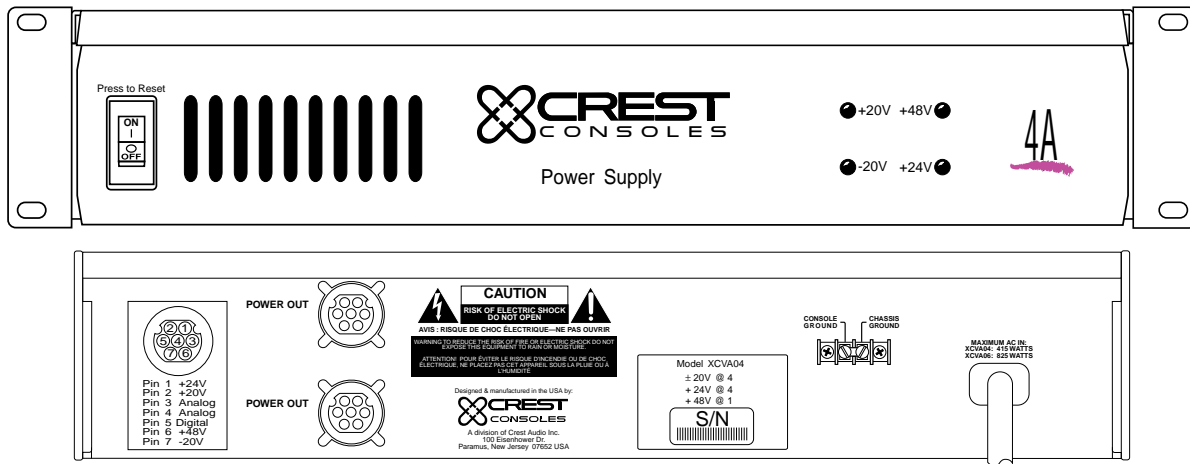

Supply Identification

The type of power supply can be identified by the model number shown on the back of the chassis and panel label..

Power Requirements

The Century Series power supplies have certain electrical requirements to operate properly. If possible the power supply should be connected to a dedicated circuit. Should any other appliance on the same circuit draw enough current to overload the circuit, the breaker or fuse will trip causing loss of power to the console. Note the maximum current draw specifications at right. Be sure that the circuit to which you connect the supply can handle the draw.

The power switch on the supply front panel is also a circuit breaker, there is no power fuse. Should the supply ever shut down, or trip at start up, simply push the switch to the off position and then on again.

Ground Linking



Safety Considerations -

Each new power supply is shipped with the AC third wire ground connected to the console chassis ground. The connection is made at the rear of the power supply unit. This is necessary for safety reasons so that exposed metal parts are grounded. In the event of a live conductor making contact with the console chassis or the power supply chassis then the current will flow to ground without a safety hazard arising. Note that when the console is disconnected from the power supply the chassis ground connection to AC third wire ground is broken and safety protection is lost. For uninterruptible grounding, in a fixed installation for example, make a connection directly to the console chassis from the safety ground. Disconnect the ground link on the rear of the power supply. This disconnects console ground from power supply AC third wire ground which would otherwise create a hum-loop.

Twin Supply Operation

When twin supplies are in use for automatic back-up, then the ground links on both supplies should be fitted.

In a situation where the safety ground to the console chassis has been connected and the ground path via the power supply is causing a hum-loop, then disconnect the ground links on BOTH power supplies.

Console and Power Supply Grounding

Console chassis ground is electrically connected to audio ground, pin 1 of XLR connectors and 1/4" sockets and to the terminal 'CONSOLE GROUND' at the rear of the power supply. The AC third wire connection in the power supply cable connects the metal chassis of the power supply to safety ground. This connection should never be disturbed. Hazardous voltages exist inside the power supply which require the case to be grounded. When rack-mounted, the power supply ground may transfer to the rack case thru the front fixing screws, though this connection is not reliable. When a console is configured within a complete sound system the grounding requirements may call for the ground link to be disconnected. This is permissible only when an alternative ground path has been provided. If in doubt seek the advice of an experienced electrical engineer.

Power Supply Model	Max Current Draw @ 120V	Max Current Draw @ 240V
XCVA04	7 Amps	4 Amps
XCVA06	9 Amps	5 Amps

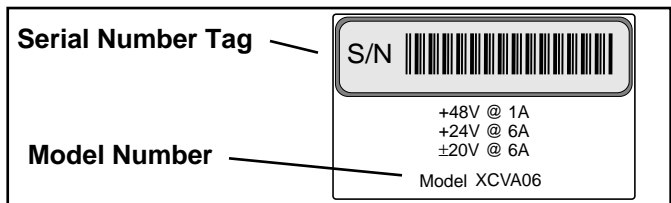

Power Connections

The connections to and from the power supply vary depending on your specific configuration. Before setting up the console, always check to make sure the AC voltage marked on the power supply agrees with the local supply. Always connect the console to the power supply before switching on the power supply. Do not run the power supply if it is not connected to the console.

Multiple power supplies can be daisy-chained to provide fail-safe protection in the event of a supply failure. When two or more supplies are used, both power supplies run all the time. In the event of supply failure, the remaining power supply(s) will take over the entire load.

NOTE: Although both of the multi-pin connectors on the back of the power supply are labeled "POWER OUT", it is necessary (and acceptable) to link two power supplies together as shown in the diagram below.

ADDITIONAL NOTE: The multi-conductor cable used for power supply-to-power supply connection is different than that used for a conventional power supply-to-console connection, and must be specified when the second power supply is ordered.

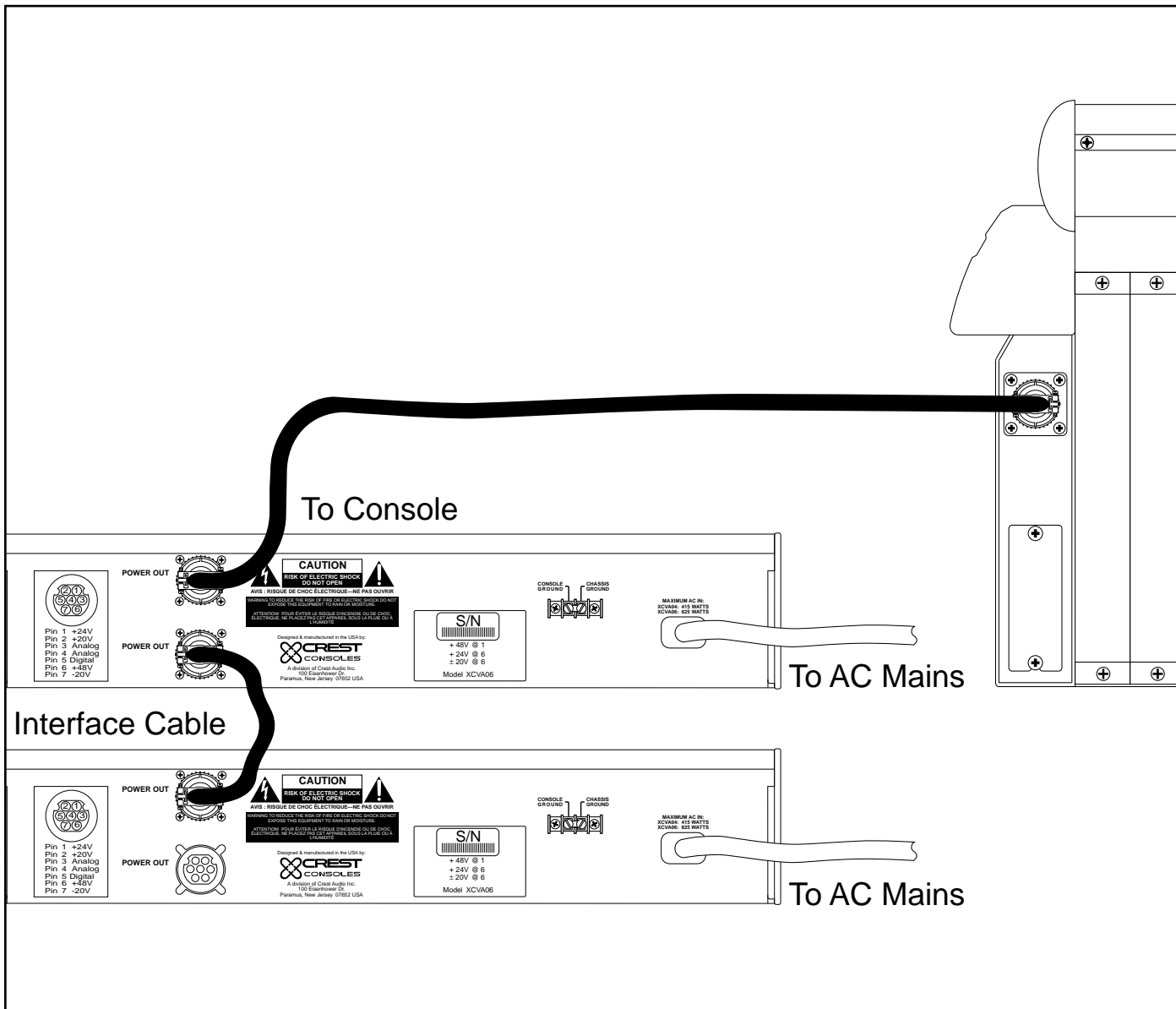

System Connections

The console is the hub of a sound system and because it controls most of the variables within a system, proper connection and component relationships are vital to assure accurate operation and results. The following diagrams illustrate conventional system connections.

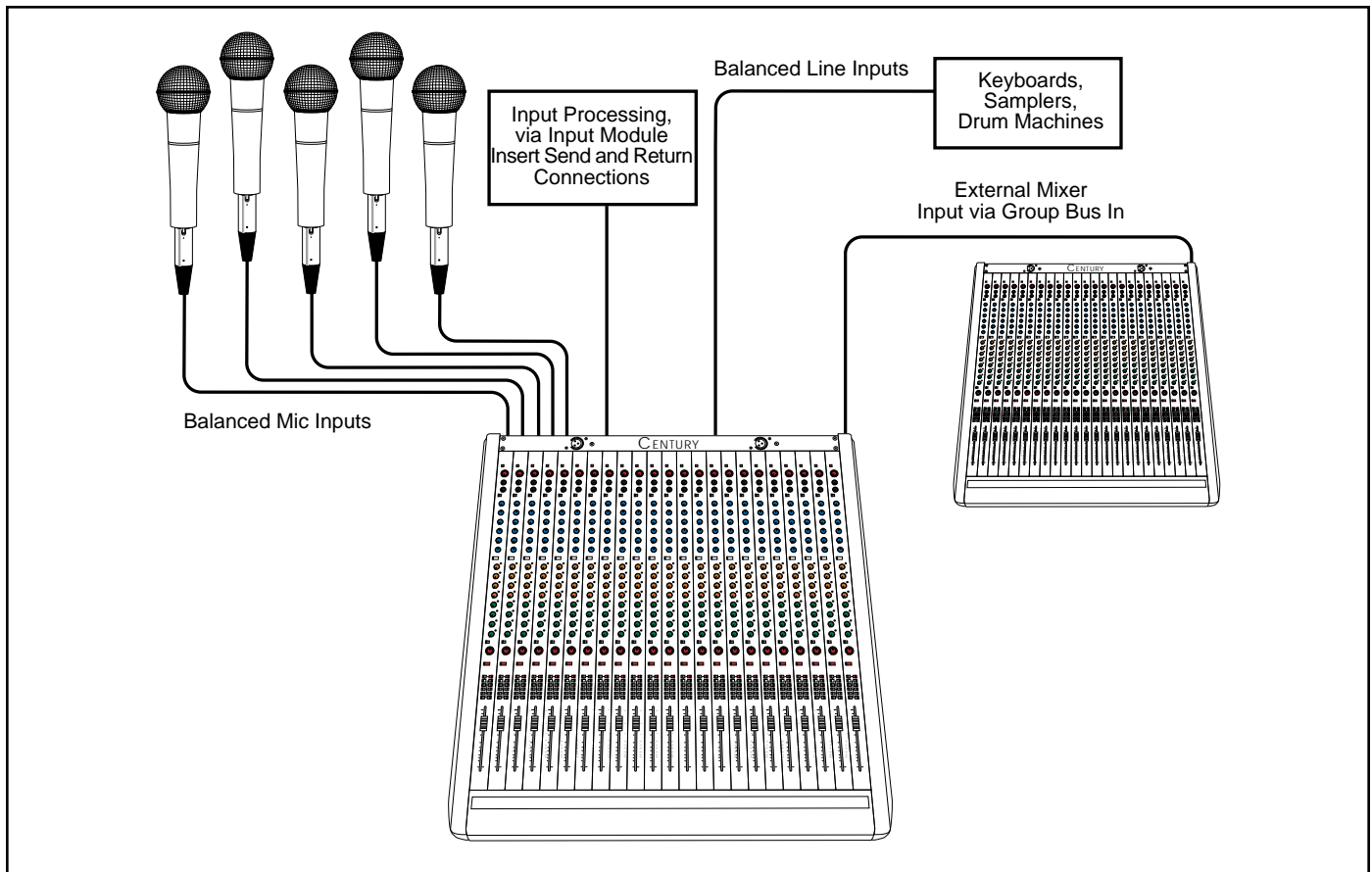

Input Connections

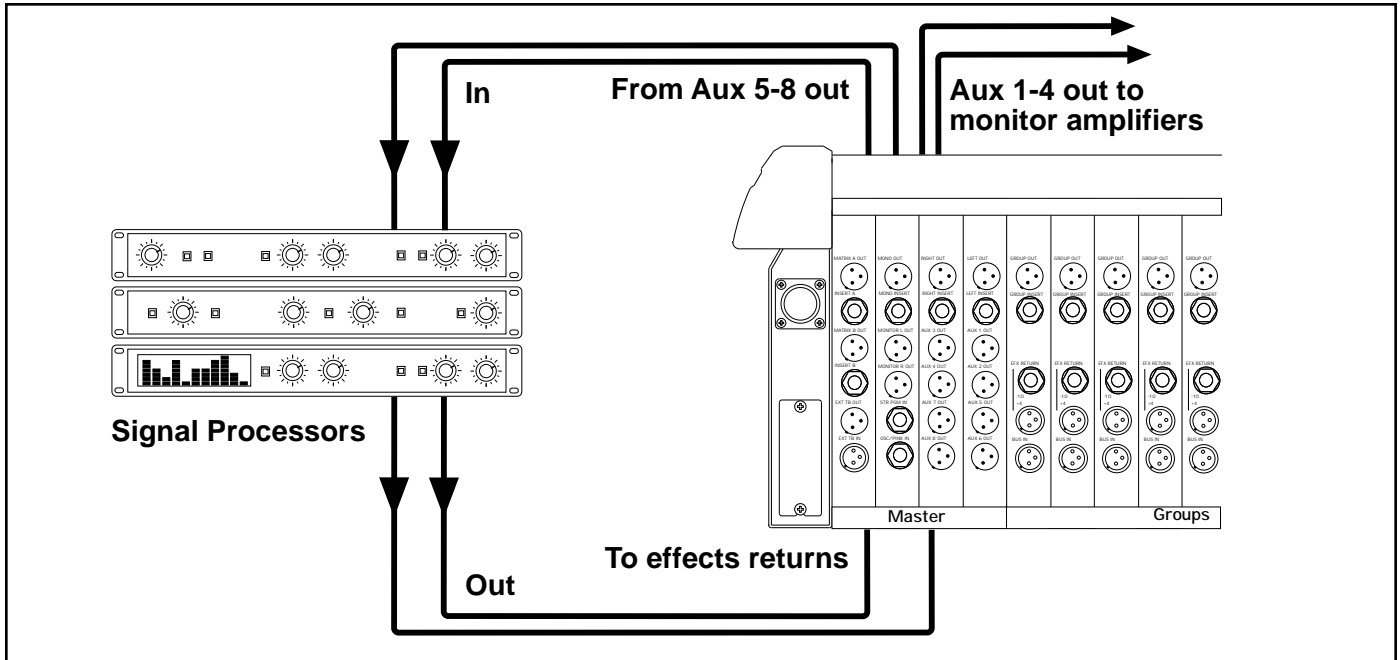

Aux Connections

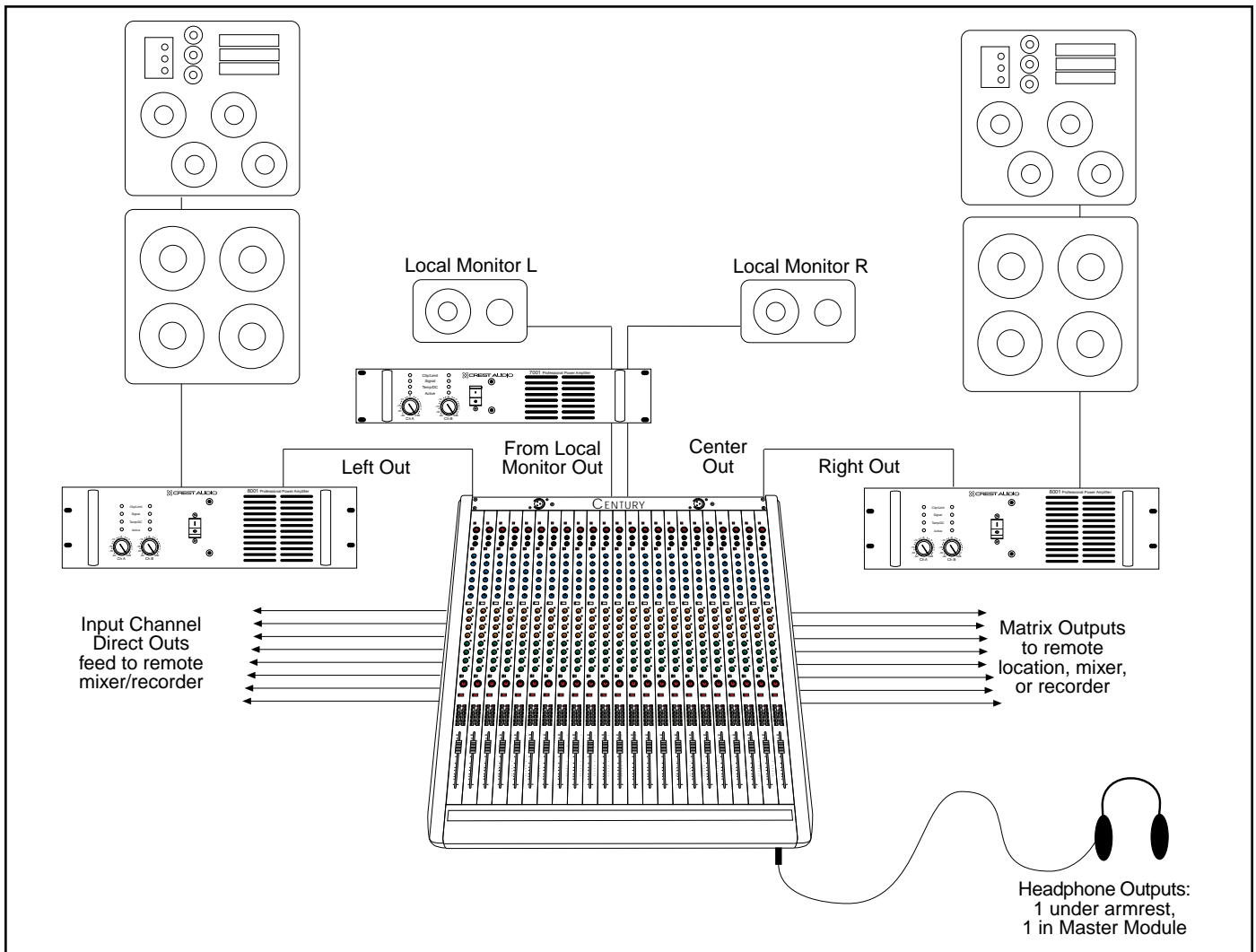

Output Connections

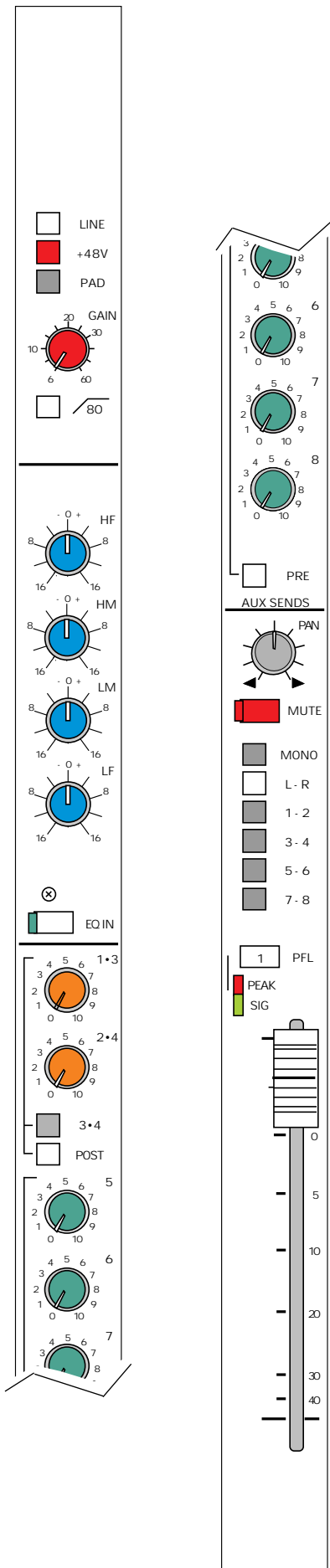

SP Input Module

The SP input module is the most straightforward of the Century Series. While it shares many features with more complex input modules, the SP input module is simple in design and operation.

LINE Switch

Selects between the Balanced XLR Microphone Input connector and the Balanced Line Input 1/4" TRS connector.

48V Phantom Power Switch

Turns on 48V Phantom Power, required by certain microphones for proper operation.

PAD Switch

Introduces a -15 dB attenuation to the mic input signal.

GAIN Control

Adjusts input gain for proper signal level.

80Hz High Pass Switch

Reduces all low frequency content at a 12db per octave rate referenced to 80Hz (-3db point).

Four Band Fixed Equalizer

Controls the cut or gain of four fixed frequencies (10 kHz, 2.7kHz, 300Hz, 80Hz) within the input signal only when the EQ IN switch is depressed.

EQ IN Switch

Inserts the EQ section into the input channel signal. An associated LED illuminates when the switch is down.

AUX Level 1•3 / 2•4

Adjusts audio level of a mix for use as a monitor or an effect send. The signal source for this mix may be selected pre or post fader by an associated switch.

AUX ASSIGNMENT 3•4 Switch

Selects the first two Aux level controls between the Aux 1•3 mix bus and the Aux 2•4 mix bus.

POST/PRE Switch

Selects the Aux 1•3 and Aux 2•4 signal sources between post and pre fader positions.

AUX 5 - 8 Individual Level Controls

Adjusts audio level of a mix for use as a monitor or an effect send. The signal source for these mixes may be selected pre or post fader by an associated switch.

PRE/POST Switch

Selects the Aux 5 through 8 signal sources between pre and post fader positions.

PAN CONTROL

Positions the channel image between the left (odd) and right (even) channel assignment.

MUTE Switch with LED

Mutes the channel and all send functions. This switch does not affect the PFL switch or the Peak and Signal Present LED indicators, The LED illuminates when the channel is muted from the local mute switch.

MONO Bus Assign Switch

Assigns the post-fader input signal directly to the Mono Clean bus.

Bus Assign Switches (L/R, 1-8)

Assigns the post Pan Signals to the mix bus in odd/even pairs. Pan controls assignment between these two mix buses with extreme left pan assigning signal exclusively to the odd mix bus and extreme right pan assigning signal exclusively to the even mix bus. When the pan is in its center position, signal is fed equally to the odd (left) and even (right) mix bus. When used in stereo applications, the channel signal may be located anywhere within the stereo image as controlled by the Pan control.

PFL Switch

Samples the channel's signal pre-fader and allows for monitoring within the master section of the console. This signal is not affected by the Mute Switch. When depressed, the signal level can be seen on the Left/Right meters, and heard via the mixer's headphone or local monitor output. When this PFL Switch is depressed, the channel PEAK LED indicator illuminates at a lower intensity. When used as a status indicator of switch position, the Peak LED indicating circuit remains fully operational by illuminating at a much higher intensity than its use as a PFL status indicator.

PEAK LED Indicator

Illuminates RED when any of the points monitored come within 3db of the clipping point. Signal is sampled after the input preamplifier stage, after the EQ section, and after the fader.

This LED also serves as a PFL ON indicator, but at a much lower intensity than when it is used to indicate clipping.

SIGNAL PRESENT LED

Constantly displays level activity of the input channel by varying in intensity.

100mm Fader

Used for control of all outputs of the channel except those Aux output sections selected by switch to a pre fader position. (The Insert Output level is not affected by the fader position.)

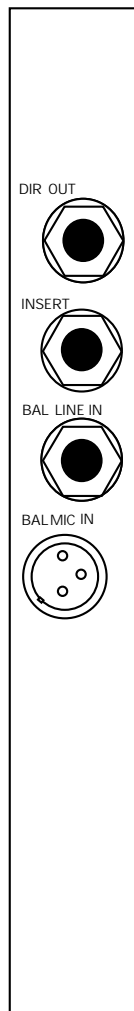

Rear Connections

Direct Out

This jack provides the direct output signal (post fader & post mute) from the associated input channel.

Insert

This jack allows for the insertion of an effect or signal processor into the audio path of the associated input channel.

Bal Line In

This jack accepts balanced and unbalanced line level inputs and delivers it into the associated input channel.

Bal Mic In

This connector accepts balanced microphone inputs for the associated input channel.

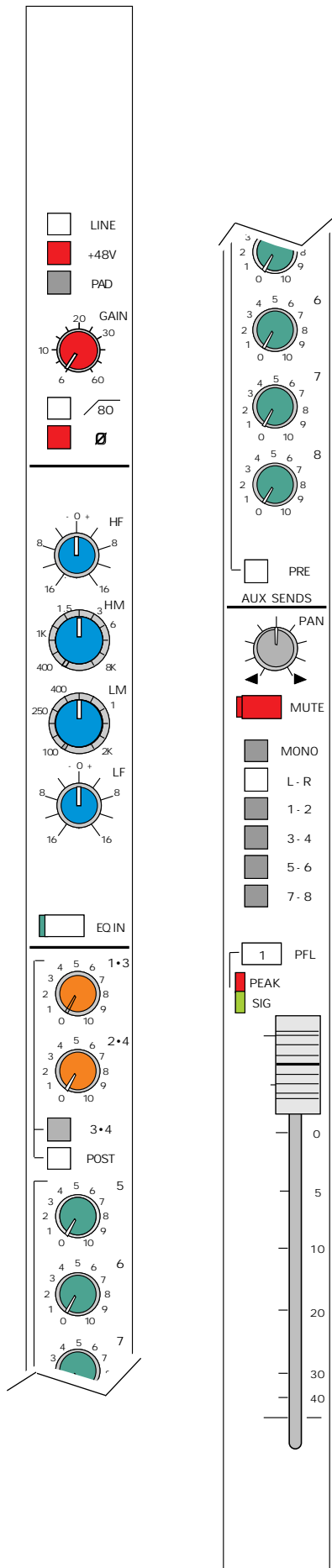

TC Input Module

The TC input module is the intermediate input module in the Century Series. It is essentially the same as the SP except for the sweepable mids on the EQ section and a polarity reverse switch.

LINE Switch

Selects between the Balanced XLR Microphone Input connector and the Balanced Line Input 1/4" TRS connector.

48V Phantom Power Switch

Turns on 48V Phantom Power, required by certain microphones for proper operation.

PAD Switch

Introduces a -15 dB attenuation to the mic input signal.

GAIN Control

Adjusts input gain for proper signal level.

Polarity Reverse Switch

Inverts the polarity of both the microphone and line inputs.

80Hz High Pass Switch

Reduces all low frequency content at a 12db per octave rate referenced to 80Hz (-3db point).

HF Equalizer Control

Boosts or cuts high frequency content at 10kHz.

MID EQ Level and Sweep Controls

Control the degree of boost or cut of Mid Frequency content and reference frequency. The outer knobs control the center frequency which is variable between the frequencies printed on the chassis. The inner knob adjusts the boost or cut.

LF Equalizer Control

Boosts or cuts low frequency content at 80Hz.

EQ IN Switch

Inserts the EQ section into the input channel signal. An associated LED illuminates when the switch is down.

AUX Level 1•3 / 2•4

Adjusts audio level of a mix for use as a monitor or an effect send. The signal source for this mix may be selected pre or post fader by an associated switch.

AUX ASSIGNMENT 3•4 Switch

Selects the first two Aux level controls between the Aux 1•3 mix bus and the Aux 2•4 mix bus.

POST/PRE Switch

Selects the Aux 1•3 and Aux 2•4 signal sources between post and pre fader positions.

AUX 5 - 8 Individual Level Controls

Adjusts audio level of a mix for use as a monitor or an effect send. The signal source for these mixes may be selected pre or post fader by an associated switch.

PRE/POST Switch

Selects the Aux 5 through 8 signal sources between pre and post fader positions.

PAN CONTROL

Positions the channel image between the left (odd) and right (even) channel assignment.

MUTE Switch with LED

Mutes the channel and all send functions. This switch does not affect the PFL switch or the Peak and Signal Present LED indicators. The LED illuminates when the channel is muted from the local mute switch or mute scene masters.

MONO Bus Assign Switch

Assigns the post-fader input signal directly to the Mono Clean bus.

Bus Assign Switches (L/R, 1-8)

Assigns the post Pan Signals to the mix bus in odd/even pairs. Pan controls assignment between these two mix buses with extreme left pan assigning signal exclusively to the odd mix bus and extreme right pan assigning signal exclusively to the even mix bus. When the pan is in its center position, signal is fed equally to the odd (left) and even (right) mix bus. When used in stereo applications, the channel signal may be located anywhere within the stereo image as controlled by the Pan control.

PFL Switch

Samples the channel's signal pre-fader and allows for monitoring within the master section of the console. This signal is not affected by the Mute Switch. When depressed, the signal level can be seen on the Left/Right meters, and heard via the mixer's headphone or local monitor output. When this PFL Switch is depressed, the channel PEAK LED indicator illuminates at a lower intensity. When used as a status indicator of switch position, the Peak LED indicating circuit remains fully operational by illuminating at a much higher intensity than its use as a PFL status indicator.

PEAK LED Indicator

Illuminates RED when any of the points monitored come within 3db of the clipping point. Signal is sampled after the input preamplifier stage, after the EQ section, and after the fader.

This LED also serves as a PFL ON indicator, but at a much lower intensity than when it is used to indicate clipping.

SIGNAL PRESENT LED

Constantly displays level activity of the input channel by varying in intensity.

100mm Fader

Used for control of all outputs of the channel except those Aux output sections selected by switch to a pre fader position. (The Insert Output level is not affected by the fader position.)

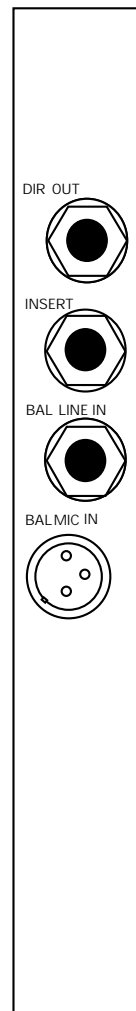

Rear Connections

Direct Out

This jack provides the direct output signal (post fader & post mute) from the associated input channel.

Insert

This jack allows for the insertion of an effect or signal processor into the audio path of the associated input channel.

Bal Line In

This jack accepts balanced and unbalanced line level inputs and delivers it into the associated input channel.

Bal Mic In

This connector accepts balanced microphone inputs for the associated input channel.

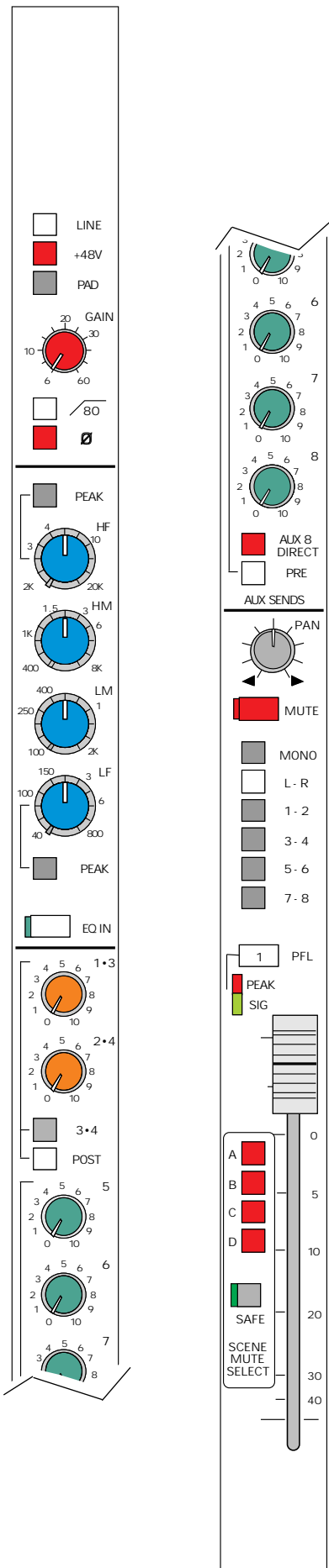

GT Input Module

The GT input Module is the most feature-filled within the Century Series. Designed for demanding FOH applications, the GT Series retains the simplicity of the whole Crest Console line while offering all the features of a high-end unit.

LINE Switch

Selects between the Balanced XLR Microphone Input connector and the Balanced Line Input 1/4" TRS connector.

48V Phantom Power Switch

Turns on 48V Phantom Power, required by certain microphones for proper operation.

PAD Switch

Introduces a -15 dB attenuation to the mic input signal.

GAIN Control

Adjusts input gain for proper signal level.

80Hz High Pass Switch

Reduces all low frequency content at a 12db per octave rate referenced to 80Hz (-3db point).

Polarity Reverse Switch

Inverts the polarity of both the microphone and line inputs.

PEAK/SHELVE HF Switch

Used for switching the high frequency EQ between the normal shelving setting to a peak setting.

Four-Band Sweep Equalizer Controls

There are two knobs for each of the four bands. The outer knobs control the center frequency which is variable between the frequencies printed on the chassis. The inner knob adjusts the boost or cut. The center frequencies are printed on the chassis around the outer knob.

PEAK/SHELVE LF Switch

Used for switching the low frequency EQ between the normal shelving setting to a peak setting.

EQ IN Switch

Inserts the EQ section into the input channel signal. An associated LED illuminates when the switch is down.

AUX Level 1•3 / 2•4

Adjusts audio level of a mix for use as a monitor or an effect send. The signal source for this mix may be selected pre or post fader by an associated switch.

AUX ASSIGNMENT 3•4 Switch

Selects the first two Aux level controls between the Aux 1•3 mix bus and the Aux 2•4 mix bus.

POST/PRE Switch

Selects the Aux 1•3 and Aux 2•4 signal sources between post and pre fader positions.

AUX 5 - 8 Individual Level Controls

Adjusts audio level of a mix for use as a monitor or an effect send. The signal source for these mixes may be selected pre or post fader by an associated switch.

Aux 8 Direct Switch

Removes the Aux 8 signal from the Aux 8 bus and assigns to the direct out 1/4" connector on the rear panel.

PRE/POST Switch

Selects the Aux 5 through 8 signal sources between pre and post fader positions.

PAN CONTROL

Positions the channel image between the left (odd) and right (even) channel assignment.

MUTE Switch with LED

Mutes the channel and all send functions. This switch does not affect the PFL switch or the Peak and Signal Present LED indicators. The LED illuminates when the channel is muted from the local mute switch.

MONO Bus Assign Switch

Assigns the input signal directly to the Mono Clean bus.

Bus Assign Switches (L/R, 1-8)

Assigns the post Pan Signals to the mix bus in odd/even pairs. Pan controls assignment between these two mix buses with extreme left pan assigning signal exclusively to the odd mix bus and extreme right pan assigning signal exclusively to the even mix bus. When the pan is in its center position, signal is fed equally to the odd (left) and even (right) mix bus. When used in stereo applications, the channel signal may be located anywhere within the stereo image as controlled by the Pan control.

PFL Switch

Samples the channel's signal pre-fader and allows for monitoring within the master section of the console. This signal *is not* affected by the Mute Switch. When depressed, the signal level can be seen on the Left/Right meters, and heard via the mixer's headphone or local monitor output. When this PFL Switch is depressed, the channel PEAK LED indicator illuminates at a lower intensity. When used as a status indicator of switch position, the Peak LED indicating circuit remains fully operational by illuminating at a much higher intensity than its use as a PFL status indicator.

PEAK LED Indicator

Illuminates RED when any of the points monitored come within 3db of the clipping point. Signal is sampled after the input preamplifier stage, after the EQ section, and after the fader.

This LED also serves as a PFL ON indicator, but at a much lower intensity than when it is used to indicate clipping.

SIGNAL PRESENT LED

Constantly displays level activity of the input channel by varying in intensity.

100mm Fader

Used for control of all outputs of the channel except those Aux output sections selected by switch to a pre fader position. (The Insert output level is not affected by the fader position.)

Scene Mute Assignments

Assign the input channel to any of the four scene mute groups. Scene mute combines with the module's local mute button, and actuates the local mute LED.

Scene Mute Safe Switch

Disables any selected scene mute assignments. An associated green LED indicates the channel is in a safe state.



Rear Connections

Direct Out

This jack provides the direct output signal (post fader & post mute) from the associated input channel.

Insert

This jack allows for the insertion of an effect or signal processor into the audio path of the associated input channel.

Bal Line In

This jack accepts balanced and unbalanced line level inputs and delivers it into the associated input channel.

Bal Mic In

This connector accepts balanced microphone inputs for the associated input channel.

GT Stereo Input Module

The GT Stereo Input Module is essentially two GT Input Modules fit into one module space. This module is very useful for accepting remote feeds, effects inputs and other signals that require stereo handling.

48V Phantom Power Switch

Turns on 48V Phantom Power for both L and R XLR inputs, required by certain microphones for proper operation.

LINE Switch

Selects between the Balanced XLR Microphone Input connector and the Balanced Line Input 1/4" TRS connector for both L and R channels.

XLR PAD Switch

Introduces a -20 dB drop to the mic input signal for both L and R XLR inputs.

L GAIN & R GAIN Controls

Adjusts input gain for proper signal level for both L and R inputs.

80Hz High Pass Switch

For both input channels, reduces all low frequency content at a 12db per octave rate referenced to 80Hz (-3db point).

Polarity Reverse Switch

For both input channels, inverts the polarity of both the microphone and line inputs. An internal jumper selects between Left channel only or both Left & Right channels.

Three-Band Equalizer Controls

The equalization controls in this module act upon both L and R stereo channels at once. The upper band is a fixed shelving EQ with one control knob. The middle and low frequency EQ bands are set up as sweep EQ's: the lower knob controls the gain or cut as in the fixed EQ; while the upper knob controls the center frequency adjusted by the inner knob. These center frequencies are printed on the chassis around the upper knob.

EQ IN Switch

Inserts the EQ section into both L and R input channel signals at once. An associated LED illuminates when the switch is down.

AUX Level 1•3 / 2•4

Adjusts audio level of a mix for use as a monitor or an effect send. The signal source for this mix may be selected pre or post fader by an associated switch. The left channel is sent to the odd Auxes, and the right channel is sent to the even Auxes.

POST/PRE Switch

Selects the Aux 1•3 and Aux 2•4 signal sources between post and pre fader positions.

STEREO Switch

AUX 5-8 Individual Level Controls normally send a summed (L+R) signal to the AUX outputs. When the STEREO switch is depressed, AUX 5 and 6 become a 'right' send and 'left' send respectively. This can be used for a stereo effects send.

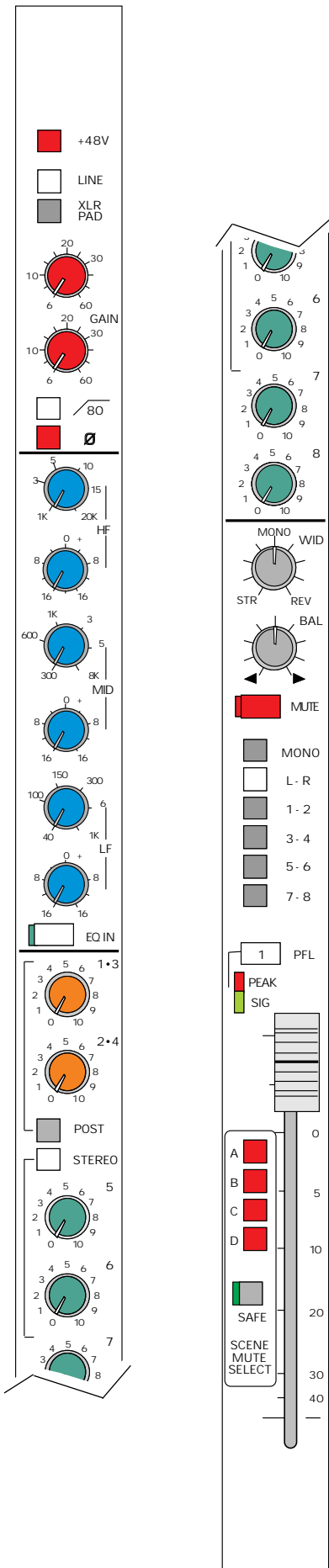

AUX 5 - 8 Individual Level Controls

Adjusts audio level of a mix for use as a monitor or an effect send. The signal source for these mixes may be selected pre or post fader by an associated switch.

WID(TH) Control

When used together with the BAL control, the WID control provides a unique way to configure stereo panning. When turned all the way counter-clockwise, this control conventionally assigns the left signal to the left (odd) channel assignment, and the right signal to the right (even) channel assignment. When adjusted to the 'twelve o'clock' position, left and right signals are panned straight up the middle, effectively summing them to mono. When this knob is turned all the way clockwise, the left and right signals are 'flip-flopped', left being assigned to the right (even) side, and the right side being assigned to the left (odd) side.

BAL Control

Positions the entire channel image between the left (odd) and right (even) channel assignment. Together with the WID control, this gives total control of the stereo image.

MUTE Switch with LED

Mutes the channel and all send functions. This switch does not affect the PFL switch or the Peak and Signal Present LED indicators. The LED illuminates when the channel is muted from the local mute switch.

MONO Bus Assign Switch

Assigns the input signal directly to the Mono Clean bus.

Bus Assign Switches (L/R, 1-8)

Assigns the post Pan Signals to mix bus in odd/even pairs. Pan controls assignment between these two mix buses with extreme left pan assigning signal exclusively to the odd mix bus and extreme right pan assigning signal exclusively to the even mix bus. When the pan is in its center position, signal is fed equally to the odd (left) and even (right) mix bus. When used in stereo applications, the channel signal may be located anywhere within the stereo image as controlled by the Pan control.

PFL Switch

Samples the channel's signal pre-fader and allows for monitoring within the master section of the console. This signal *is not* affected by the Mute Switch. When depressed, the signal level can be seen on the Left/Right meters, and heard via the mixer's headphone or local monitor output. When this PFL Switch is depressed, the channel PEAK LED indicator illuminates at a lower intensity. When used as a status indicator of switch position, the Peak LED indicating circuit remains fully operational by illuminating at a much higher intensity than its use as a PFL status indicator.

PEAK/PFL LED Indicator

Illuminates RED when any of the points monitored come within 3db of the clipping point. Signal is sampled after the input preamplifier stage, after the EQ section, and after the fader.

This LED also serves as a PFL ON indicator, but at a much lower intensity than when it is used to indicate clipping.

SIGNAL PRESENT LED

Constantly displays level activity of the input channel by varying in intensity.

100mm Fader

Used for control of all outputs of the channel except those Aux output sections selected by switch to a pre fader position. (The Insert output level is not affected by the fader position.)

Scene Mute Assignments

Assign the input channel to any of the four scene mute groups. Scene mute combines with the module's local mute button, and actuates the local mute LED.

Scene Mute Safe Switch

Disables any selected scene mute assignments. An associated green LED indicates the channel is in a safe state.

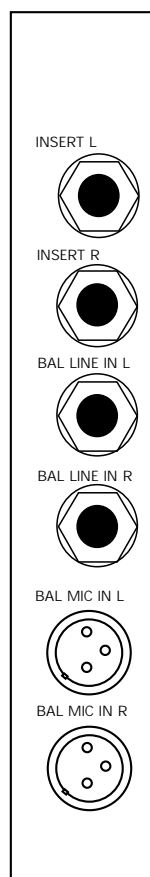

Rear Connections

Direct Out

This jack provides the direct output signal (post fader & post mute) from the associated input channel.

Insert

This jack allows for the insertion of an effect or signal processor into the audio path of the associated input channel.

Bal Line In

This jack accepts balanced and unbalanced line level inputs and delivers it into the associated input channel.

Bal Mic In

This connector accepts balanced microphone inputs for the associated input channel.

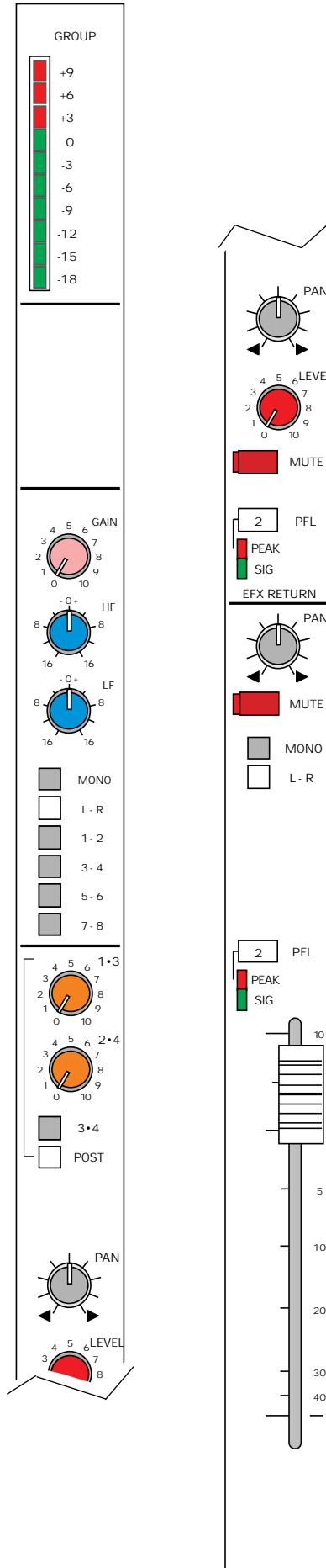

SP/TC Group Modules

Since there are only minor differences between the SP and TC input modules, these two models share the same group module. An eight bus console will have eight of these modules where a four bus console will only have four. The number of the group is indicated on the PFL switch.

Group Meter

Monitors the post-fader output of the group via a ten-segment LED array.

Effect Return Gain

Controls the gain on the signal returning from an attached effect.

Effect Return EQ

Alters the effect return signal pre-fader via two fixed-frequency (10kHz and 80 Hz) controls.

Effect Return Assignments

Assign the post-pan, post fader, effect return signal to the mix bus.

Effect Aux Levels

Controls the level of effect return signal sent to Auxes 1-4.

Aux 3•4 Switch

Switches the Effect Aux Levels between 1•2 and 3•4.

Pre/Post Switch

Selects the effect return signal between pre and post Effect Level Control, for use with Aux's.

Effect Pan

Adjust the proportion of effect return signal being sent to the Left (odd) and Right (even) mix buses.

Effect Level

Adjusts the final effect return signal level.

Effect Mute

Mutes the effect return signal.

Effect PFL

Allows for Pre Fader Listening of the effect return signal.

Effect Peak & Signal LED's

The red LED indicates that the effect signal is within 3dB of the clipping point. The green LED constantly displays the level of signal activity by varying in intensity.

Group Pan

Used to position group image between the Left and Right output assignments

Group Mute

Mutes the group signal, except for the group insert send.

Group Assignments

Assigns the group signal to the Left, Right, and/or Mono outputs.

Group PFL

Allows for Pre Fader Listening of the group signal

Group Peak & Signal LED's

The red LED indicates that the group signal is within 3dB of the clipping point. The green LED constantly displays the level of signal activity by varying in intensity.

Group Fader

Controls the final output signal of the group.

Rear Connections

Group Out

This connector carries the post-fader output signal from the associated group module.

Group Insert

This jack allows for the insertion of an effect or signal processor into the audio path of the associated group.

EFX Return

These two connectors allow for effect signals to be brought back into the board. The 1/4" TRS jack accepts a balanced or unbalanced signal at -10 dB level and delivers the signal to the EFX return section. The female XLR connector accepts a balanced signal at +4dB level and delivers the signal to the EFX return section of the group.

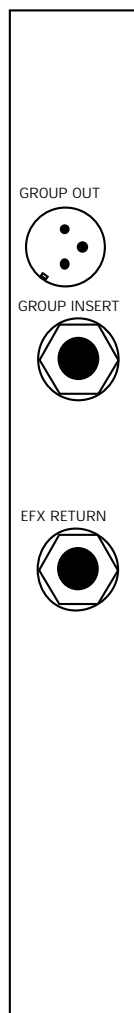

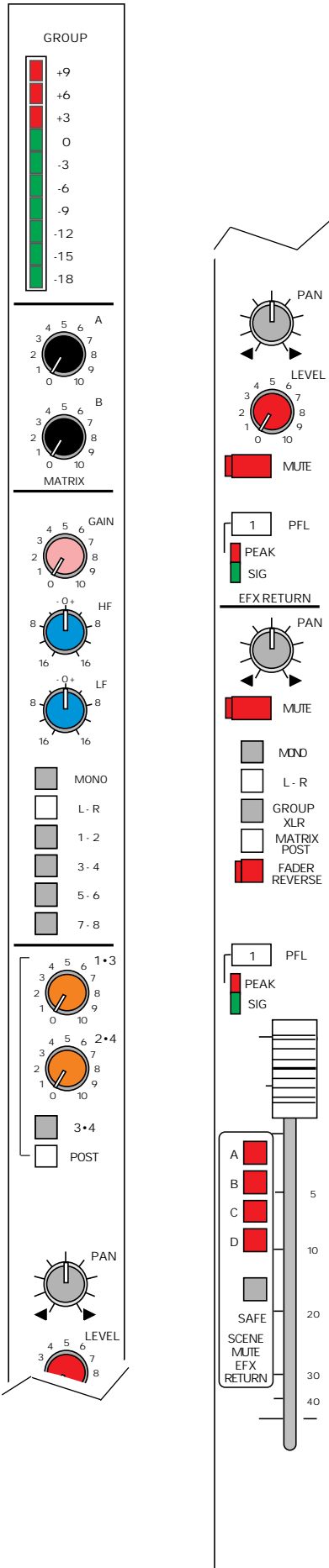

GT Group Module

The GT group module has many of the same features as the SP/TC group module. Primarily it is the Matrix Section and the Scene Mute controls that separate this group module from the SP/TC. An eight bus console will have eight of these modules where a four bus console will only have four. The number of the group is indicated on the PFL switch.

Group Meter

Monitors the post-fader output of the group via a ten-segment LED array.

Matrix Levels (A, B)

Adjusts the level of group signal sent to the respective matrix.

Effect Return Gain

Controls the gain on the signal returning from the attached effect

Effect Return EQ

Alters the effect return signal pre-fader via two fixed-frequency (10kHz and 80 Hz) controls.

Effect Return Assignments

Assign the post-pan, post fader, effect return signal to the mix bus.

Effect Aux Sends

Controls the level of effect return signal sent to Auxes 1-4.

Aux 3•4 Switch

Switches the Aux Levels between 1•3 and 2•4.

Pre/Post Switch

Selects the effect return signal between pre and post Effect Level Control.

Effect Pan

Adjust the proportion of effect return signal being sent to the Left (odd) and Right (even) mix buses.

Effect Level

Adjusts the final effect return signal level.

Effect Mute

Mutes the effect return signal.

Effect PFL

Allows for Pre Fader Listening of the effect return signal.

Effect Peak & Signal LED's

The red LED indicates that the effect signal is within 3dB of the clipping point.

The green LED constantly displays the level of signal activity by varying in intensity.

Group Pan

Used to position group image between the Left and Right output assignments.

Group Mute

Mutes the group signal except for the group insert send.

Group Assignments

Assigns the group signal to the Left, Right, and or Mono outputs.

Group XLR

Turns on the balanced XLR output.

Matrix Pre/Post

Switches the Matrix sends between pre and post-fader settings.

Fader Reverse w/LED

Swaps functions between the Effect Level control and the group fader; i.e., one becomes the other and vice versa.

Group PFL

Allows for Pre Fader Listening of the Group signal.

Group Peak & Signal LED's

The red LED indicates that the group signal is within 3dB of the clipping point.

The green LED constantly displays the level of group signal activity by varying in intensity.

Group Fader

Controls all post-fader group signal outputs.

EFX Return Scene Mute

Assignments

Assign the EFX return signal to any of the four scene mute groups. Scene mute combines with the effect's local mute button, and actuates the local mute LED.

EFX Return Scene Mute Safe Switch

Disables all selected EFX scene mute assignments. An associated green LED indicates the return is in a safe state.

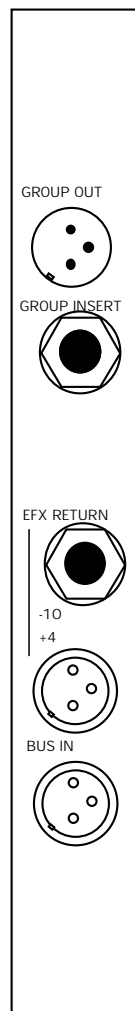

Rear Connections

Group Out

This connector carries the post-fader output signal from the associated group module.

Group Insert

This jack allows for the insertion of an effect or signal processor into the audio path of the associated group.

EFX Return

These two connectors allow for effect signals to be brought back into the board. The 1/4" TRS jack accepts a balanced or unbalanced signal at -10 dB level and delivers the signal to the EFX return section. The female XLR connector accepts a balanced signal at +4dB level and delivers the signal to the EFX return section of the group.

Bus In

This connector accepts a balanced signal at +4dB level, and then sums it with all the other signals assigned to the associated groups.

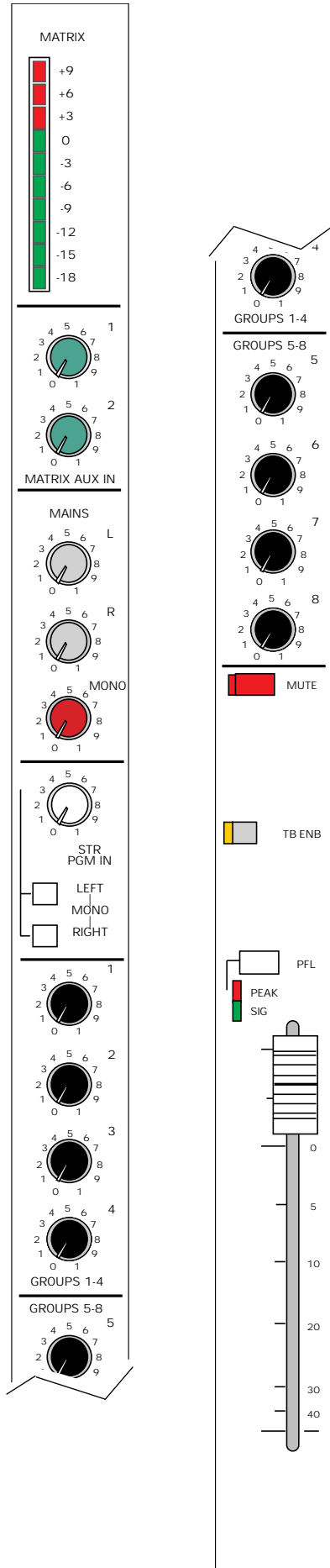

Matrix Module

The Matrix Module allows the creation of an independent mix using the Main outputs (and an External Input) as signal sources.

Matrix AUX IN Controls

Controls level of external balanced input signals.

L & R MAINS Controls

Controls level of post fader L & R signals from main section.

MONO MAINS Control

Controls the level of post fader Mono signal from main section.

STR PGM IN Control

Controls level of Stereo Program being input into the matrix. (These switches do not function on the SP/TC Consoles)

LEFT/MONO/RIGHT Switches

Selects which main section signals are introduced into the matrix. (These switches do not function on the SP/TC Consoles)

GROUPS 1-4 Controls

Adjusts the level of Group signals 1-4 introduced into the matrix.

GROUPS 5-8 Controls

Adjusts the level of Group signals 5-8 introduced into the matrix.

MUTE Switch with LED

Mutes the output. This switch does not affect the PFL switch or the Peak and Signal Present LED indicators.

TB ENABLE Control

Injects the talkback signal from the Master section into the matrix.

PFL Switch

Samples the matrix signal pre-fader and allows for monitoring within the master section of the console. This signal *is not* affected by the Mute Switch. When depressed, the signal level can be seen on the Left/Right meters, and heard via the mixer's headphone or local monitor output. When this PFL Switch is depressed, the PEAK LED illuminates at a lower intensity. When used as a status indicator of switch position, the Peak LED indicating circuit remains fully operational by illuminating at a much higher intensity than its use as a PFL status indicator.

PEAK LED Indicator

Illuminates RED when any of the points monitored come within 3db of the clipping point. Signal is sampled after the input preamplifier stage and after the fader.

This LED also serves as a PFL ON indicator, but at a much lower intensity than when it is used to indicate clipping.

SIGNAL PRESENT LED

Constantly displays level activity of the matrix by varying in intensity.

100mm Fader

Used for control of all outputs of the channel. (The Insert output level is not affected by the fader position.)

Rear Connections

Matrix Out

This connector delivers a balanced signal from the matrix module.

Matrix Insert

This jack allows for the insertion of an effect or signal processor into the audio path of the matrix output.

Aux In 1

This connector accepts a balanced signal at +4dB level, and then sums it with all the other signals in the matrix output.

Aux In 2

This connector accepts a balanced signal at +4dB level, and then sums it with all the other signals in the matrix output.

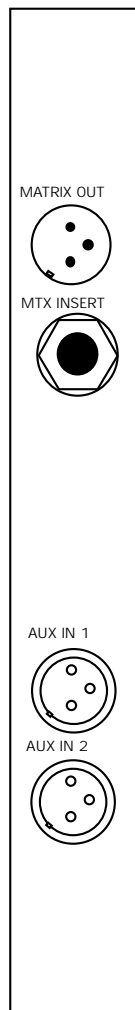

LEFT

RIGHT

LAMP DIM

DC POWER

PFL ON

HEADPHONES

PHONES

LOCAL MONITOR

MONITOR CONTROL

LEVEL METER

MONO

L - R

GROUPS

AUX

1 • 2

3 • 4

ON

1

2

3

4

5

6

7

8

LEV

MONO

L - R

GROUPS

AUX

1 • 2

3 • 4

ON

AFL1

AFL2

AFL3

AFL4

AFL5

AFL6

AFLON

AFLON

AFLON

AFLON

AFLON

AFLON

PEAK SIG

PEAK SIG

PEAK SIG

1

2

3

4

5

6

7

8

AFL1

AFL2

AFL3

AFL4

AFL5

AFL6

AFLON

AFLON

AFLON

AFLON

AFLON

AFLON

MONO

L - R

GROUPS

AUX

1 • 2

3 • 4

ON

1

2

3

4

5

6

7

8

LEV

MONO

L - R

GROUPS

AUX

1 • 2

3 • 4

ON

MUTE

MUTE

MUTE

MONO

MONO

MONO

LEFT

RIGHT

MONO

PFL

PEAK SIG

PFL

PEAK SIG

PFL

PEAK SIG

0

15

20

30

40

50

0

15

20

30

40

50

0

15

20

30

40

50

SP/TC Master Section

Left & Right Meters

Monitors the post-fader output of the Left & Right channels, and any PFL'd or AFL'd signals, via a ten-segment LED array.

Power Indicators

These four LED's indicate the status of the four types of power used by Century Series Consoles.

Headphone Jack

Delivers right and left output, unless a PFL or AFL switch is depressed. Whenever any signal is in PFL or AFL mode the headphone jack will deliver that signal. An additional headphone jack is located underneath the hand rest on the right-front part of the console.

Headphone Level Control

Controls signal level delivered to the two headphone jacks.

Local Monitor Level Control

Controls signal level delivered to the local monitor outputs.

PFL Defeat

Disables PFL function to the local monitor, permitting local monitor output to function as an additional left/right output.

Dim Switch

Introduces -12 dB attenuation into local monitor output. Local monitors are automatically dimmed when Talkback is engaged.

Mono Switch

Switches local monitor from stereo mode to mono mode.

Local Monitor Mute

Mutes the local monitor signal output.

Aux Master Controls

Controls final output signal level of eight auxiliary outputs.

Aux AFL Switches

Switch the eight auxiliary outputs to After Fader Listening mode, via the normal PFL signal path. The AUXes can be monitored as stereo pairs if both AFL switches are depressed. If only one is depressed, that AUX is monitored in mono.

Talkback Level Control

Controls the level of talkback signal output, and dims the local monitor, whether or not the Dim switch has been pressed.

Talkback Assignment Switches

Assign the talkback signal to the outputs, groups and or auxes.

Talkback On/Off Switch

Turns the talkback system on and off.

L/R/Mono Mute Switches

Mute outputs of the Left, Right and Mono signals respectively.

L/R Mono Assignment Switches

Assign the Left and Right signals to the Mono output.

L/R/Mono PFL Switches

Allow for Pre Fader Listening of the Right, Left and Mono output signals.

L/R/Mono Peak & Signal LED's

Red LEDs indicate the signal is within 3dB of clipping point.

The green LED indicates the level of signal activity by varying in intensity.

L/R/Mono Faders

Adjust final signal level of the Right, Left and Mono outputs.

Talkback Mic Input

Allows a microphone to be plugged in for use with the talkback system. This jack is located next to the headphone jack on the front-right of the console under the arm rest.

Rear Connections

Mono Out

Delivers balanced post-fader signal containing all signals assigned to the Mono Clean Bus.

Right Out

Delivers a balanced post-fader signal containing all signals assigned to the right output.

Left Out

Delivers a balanced post-fader signal containing all signals assigned to the left output.

Mono Insert

This jack allows for the insertion of a signal processor into the path of the mono sub-mix.

Right Insert

This jack allows for the insertion of an effect or signal processor into the audio path of the right sub-mix.

Left Insert

This jack allows for the insertion of an effect or signal processor into the audio path of the left sub-mix.

Monitor Out (R&L)

These two connectors deliver a balanced signal from the left and right local monitor.

Aux 1-8 Out

These eight connections provide the balanced output signals from their respective auxiliary buses.

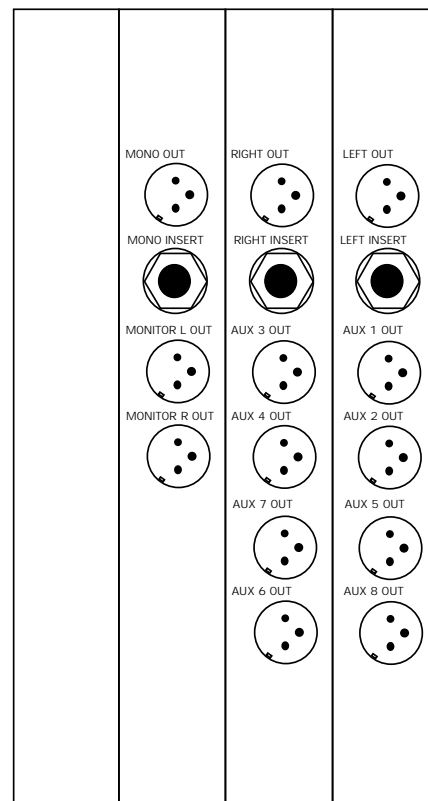

GT Master Section

This master section is the control center for most of the GT's advanced functions.

Left & Right Meters

Monitors the post-fader output of the Left & Right channels, and any PFL'd signals, via a ten-segment LED array.

Lamp Dim Control

Controls the intensity of the lighting devices plugged into the XLR sockets on the light bar.

Talkback Mic Input

Allows for a gooseneck microphone to be plugged in for use with the talkback system. An additional Talkback Mic Input jack can be found next to the headphone jack on the front-right of the console under the arm rest.

Power Indicators

These four LED's indicate the status of the four types of power used by Century Series Consoles.

Headphone Jack

Delivers right and left output, unless a PFL switch is depressed. Whenever any signal is in PFL mode, the headphone jack will deliver that signal. An additional headphone jack is located beneath the hand rest on the right-front part of the console.

Headphone Level Control

Controls the signal level delivered to the headphone jacks.

L, R & Mono Matrix Sends

Controls level of Right, Left and Mono signals sent to the two matrices.

Local Monitor Level Control

Controls level of signal delivered to the monitor outputs.

Auxiliary Mutes

Mutes the respective auxiliary signals.

PFL Defeat

Disables PFL function to the local monitor, allowing local monitor output to function as an additional left/right output.

Dim Switch

This switch introduces a -12 dB attenuation into the local monitor and headphone outputs.

Mono Switch

Switches the local monitor and headphone outputs from their standard stereo mode to a mono mode.

Stereo Program In Gain

Adjusts the gain of the Stereo Program In signal.

Stereo Program In EQ

Two-band fixed frequency (10kHz and 80Hz) EQ that affects the Stereo Program In signal.

Stereo Program In Assignments

Assigns the Stereo Program to the associated buses.

Local Monitor Mute

Mutes the local monitor signal output.

Aux Master Controls

Controls final output signal level of the auxiliary outputs.

Aux AFL Switches

Switch the eight auxiliary outputs to After Fader Listening mode, via normal PFL signal path. AUXes can be monitored as stereo pairs if both AFL switches are depressed. If only one is depressed, that AUX is monitored in mono.

External Oscillator Switch

Turns on the internal oscillator or accepts signal from the 1/4" TRS Oscillator input jack.

External Talkback Input Switch

Selects the external talkback input XLR as an input signal to the talkback section and overrides the Oscillator.

Stereo Program Balance

Adjusts balance of stereo signal from Stereo Program input.

Stereo Program Level

Controls final output signal level of the Stereo Program.

Talkback Level Control

Controls the level of the selected talkback source.

External Talkback Output Switch

Turns on the external talkback XLR.

Stereo Program Mute

Mutes the output of the stereo program.

Stereo Program PFL

Allows Pre Fader Listening of the Stereo Program signal.

Talkback Assignment Switches

Assigns talkback signal to outputs, groups, auxes, or matrices.

Blend Level

Controls level of L & R signal blended to assigned auxes.

Blend Assignment Switches

Assigns the Left and Right signals to the respective auxes.

Talkback On/Off Switch

Turns the talkback system on and off, and dims local monitor, whether or not Dim switch has been pushed.

Matrix Master Levels (A&B)

Controls the final output level of the respective matrix.

Matrix Master Mutes (A&B)

Mutes the respective matrix signal.

Matrix Master PFL (A&B)

Allows Pre-Fader Listening of the respective matrix signal.

Scene Mute Master Switches

Turn on and off the four scene mutes.

Aux Scene Mute On/Off Switch

Turns the Aux Scene Mute system on and off.

L/R/Mono Mute Switches

Mute outputs of Left, Right and Mono signals respectively.

(Continued)

GT Master Section (cont'd)

L&R Mono Assignment Switches

Assign the Left and Right signals to the Mono output..

L/R/Mono Matrix Post Switches

Switches the Left, Right and Mono matrix signals between pre and post fader.

L/R/Mono PFL Switches

Allow for Pre-Fader Listening of the Left, Right and Mono signals respectively.

L/R/Mono Peak & Signal LED's

The red LED indicates that the signal is within 3dB of the clipping point. The green LED constantly displays the level of signal activity by varying in intensity.

L/R/Mono Faders

Adjust final output signal level of Right, Left and Mono outputs.

Rear Connections

Matrix Out (A&B)

These two connectors deliver a balanced signal from the associated matrix master.

Mono Out

This connector delivers a balanced post-fader signal containing all signals assigned to the Mono Clean Bus.

Right Out

This connector delivers a balanced post-fader signal containing all signals assigned to the right output.

Left Out

This connector delivers a balanced post-fader signal containing all signals assigned to the left output.

Matrix Insert (A&B)

This jack allows for the insertion of an effect or signal processor into the audio path of the associated matrix.

Mono Insert

This jack allows for the insertion of a signal processor into the path of the mono sub-mix.

Right Insert

This jack allows for the insertion of an effect or signal processor into the audio path of the right sub-mix.

Left Insert

This jack allows for the insertion of an effect or signal processor into the audio path of the left sub-mix.

Monitor Out (R&L)

These two connectors deliver a balanced signal from the left and right local monitor.

Aux 1-8 Out

These eight connections provide the balanced output signals from their respective auxiliary buses.

Ext. Talkback Out

This connector provides an external balanced signal from the selected talkback source.

Ext. Talkback In

This connector accepts a balanced signal which is assignable to any of the locations in the talkback system.

Stereo Program In

This jack accepts an unbalanced stereo line level signal for use as warm-up or break music.

Oscillator / Pink Noise In

This connector accepts a balanced or unbalanced signal from an oscillator or pink noise generator. This signal is assignable via the talkback assignment switches.

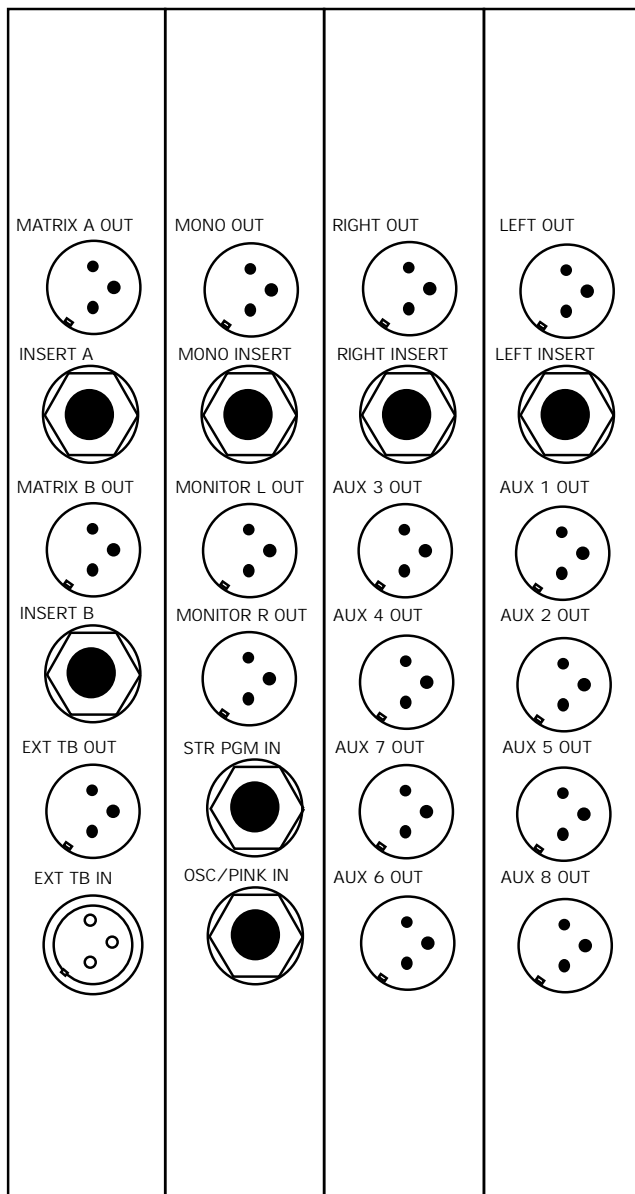

GT TC SP

Appendix A

Technical Information

General Specifications - SP Console

The following are the technical specifications for the Century SP console.

Frequency Response	
+0.0, -0.5dB, 20Hz to 20 kHz (referenced to 1kHz)	
Total Harmonic Distortion	
Mic input to Group output 20Hz to 20 kHz at +15dBu	<0.01%
Noise (22Hz to 22kHz)	
Mic EIN	-129 dBu
Mix Bus Output Noise (20 ch routed)	- 80 dBu
Aux Bus Output Noise (20 ch routed)	- 80 dBu
Crosstalk (Measured at 1kHz)	
Channel Mute	>102 dB
Channel Fader Attenuation	> 96 dB
Channel Routing	> 85 dB
Channel Aux Send Attenuation	> 93 dB
Input/Output Impedances	
Mic Input	4kΩ balanced
Line Input	>10kΩ balanced
Outputs	140Ω balanced
Input/Output Levels (0VU = +4 dBu, 1.23V RMS)	
Mic Input Sensitivity	+ 4 to -62 dBu
Line Input Sensitivity	+ 12 to -38 dBu
Input Insertion Point Level	+ 4 dBu
Output Insertion Point Level	- 2 dBu
Nominal Output Level	+ 4 dBu
Maximum Balanced Output Level	+28 dBu

Configurations

SP Consoles are available in the following configurations:

Four Subgroup	16, 24, 32, 36, 44, or 56 inputs
Eight Subgroup	12, 20, 28, 32, 40, or 52 inputs
Optional stereo input modules and matrix modules are available.	

Architect's & Engineer's Specifications - SP Console

The following text should be used when specifying a Century SP in a bid or proposal.

The live sound console shall be constructed in a modular fashion and be housed in a steel frame with molded plastic side panel/carrying handles. The console shall be black with white labeling and utilize XLR lighting device connectors. The console shall have an XLR talkback mic connector and a headphone jack. These shall be located beneath the far right side of the armrest.

All microphone inputs shall be electronically balanced and accessed via 3-pin XLR connectors and have an EIN of -129 dBm. All line inputs shall be electronically balanced and accessed via 1/4" TRS jacks. The insert points shall be via 1/4" TRS jacks.

Each input channel shall have: a +48 volt phantom power switch, a -15 dB mic pad switch, a 80Hz high pass filter switch, and 4-band fixed EQ (80Hz, 300Hz, 2.7kHz, 10kHz) with an EQ In switch. Each input channel shall also have: a FET controlled (10 millisecond ramp) mute switch with LED, sub-group assignment switches, a L/R assignment switch, a dedicated mono assignment switch, a dynamic signal present LED and peak LED, a PFL switch, and a 100mm long throw fader. Each input channel shall have eight auxiliary sends which shall be controlled via six knobs and three switches. The aux sends shall have a pre/post fader switch for every four sends. The aux sends shall be selectable pre or post fader.

The console shall be available in four or eight bus configurations. Each group module shall have a ten-segment LED meter array. The effect return section of each group module shall have a gain control, a two-band fixed EQ, sub-group assignment switches, a L/R assignment switch, a dedicated mono assignment switch, two aux send controls, a pan control, a level control, a dynamic signal present LED and peak LED, and a PFL switch. The remainder of the group module shall have a pan control, an FET controlled (10 millisecond ramp) mute switch with LED, assignment switches for: mono and L/R. A PFL switch, dynamic signal present LED and peak LED, and a 100mm long throw fader shall also be provided on the group module.

The master section shall be four modules in width and have the following features: eight aux master controls with associated AFL switches, a 100mm long throw fader for each of the three master outputs and a comprehensive talkback system.

The power supply shall be housed in a 14 ga. steel chassis that shall occupy two 19" rack spaces. The power supply shall have the ability to be daisy-chained to additional power supplies to provide a fail-safe operating environment. Connection of two or more power supplies shall not require additional interface hardware other than the provided cable.

The live sound console shall be: the Crest Audio Century SP.

General Specifications - TC Console

The following are the technical specifications for the Century TC console.

Frequency Response	
+0.0, -0.5dB, 20Hz to 20 kHz (referenced to 1kHz)	
Total Harmonic Distortion	
Mic input to Group output 20Hz to 20 kHz at +15dBu	<0.01%
Noise (22Hz to 22kHz)	
Mic EIN	-129 dBu
Mix Bus Output Noise (20 ch routed)	- 80 dBu
Aux Bus Output Noise (20 ch routed)	- 80 dBu
Crosstalk (Measured at 1kHz)	
Channel Mute	>102 dB
Channel Fader Attenuation	> 96 dB
Channel Routing	> 85 dB
Channel Aux Send Attenuation	> 93 dB
Input/Output Impedances	
Mic Input	4k Ω balanced
Line Input	>10k Ω balanced
Outputs	140 Ω balanced
Input/Output Levels (0VU = +4 dBu, 1.23V RMS)	
Mic Input Sensitivity	+ 4 to -62 dBu
Line Input Sensitivity	+ 12 to -38 dBu
Input Insertion Point Level	+ 4 dBu
Output Insertion Point Level	- 2 dBu
Nominal Output Level	+ 4 dBu
Maximum Balanced Output Level	+28 dBu

Configurations

TC Consoles are available in the following configurations:

Four Subgroup	16, 24, 32, 36, 44, or 56 inputs
Eight Subgroup	12, 20, 28, 32, 40, or 52 inputs
Optional stereo input modules and matrix modules are available.	

Architect's & Engineer's Specifications - TC Console

The following text should be used when specifying a Century TC in a bid or proposal.

The live sound console shall be constructed in a modular fashion and be housed in a steel frame with molded plastic side panel/carrying handles. The console shall be black with white labeling and utilize XLR lighting device connectors. The console shall have an XLR talkback mic connector and a headphone jack. These shall be located beneath the far right side of the armrest.

All microphone inputs shall be electronically balanced and accessed via 3-pin XLR connectors and have an EIN of -129 dBm. All line inputs shall be electronically balanced and accessed via 1/4" TRS jacks. The insert points shall be via 1/4" TRS jacks.

Each input channel shall have: a +48 volt phantom power switch, a -15 dB mic pad switch, a 80Hz high pass filter switch, a polarity reverse switch and 4-band (LF-80Hz, LMF-100Hz-2kHz, HMF-400Hz-8kHz, HF-10kHz) mid-sweepable EQ an EQ In switch. Each input channel shall also have: a FET controlled (10 millisecond ramp) mute switch with LED, sub-group assignment switches, a L/R assignment switch, a dedicated mono assignment switch, a dynamic signal present LED and peak LED, a PFL switch, and a 100mm long throw fader.

Each input channel shall have eight auxiliary sends which shall be controlled via six knobs and four switches. The aux sends shall have a pre/post fader switch for every four sends. The aux sends shall be selectable pre or post EQ and pre or post mute. There shall be an Aux 8 direct switch that shall allow the Aux 8 rotary knob to directly control the output of the 1/4" direct out TRS jack.

The console shall be available in four or eight bus configurations. Each group module shall have a ten-segment LED meter array. The effect return section of each group module shall have a gain control, a two-band fixed EQ, sub-group assignment switches, a L/R assignment switch, a dedicated mono assignment switch, two aux send controls, a pan control, a level control, a dynamic signal present LED and peak LED, and a PFL switch. The remainder of the group module shall have a pan control, an FET controlled (10 millisecond ramp) mute switch with LED, assignment switches for: mono and L/R. A PFL switch, dynamic signal present LED and peak LED, and a 100mm long throw fader shall also be provided on the group module.

The master section shall be four modules in width and have the following features: eight aux master controls with associated AFL switches, a 100mm long throw fader for each of the three master outputs and a comprehensive talkback system.

The power supply shall be housed in a 14 ga. steel chassis that shall occupy two 19" rack spaces. The power supply shall have the ability to be daisy-chained to additional power supplies to provide a fail-safe operating environment. Connection of two or more power supplies shall not require additional interface hardware other than the provided cable.

The live sound console shall be: the Crest Audio Century TC.

General Specifications - GT Console

The following are the technical specifications for the Century GT console.

Frequency Response	
+0.0, -0.5dB, 20Hz to 20 kHz (referenced to 1kHz)	
Total Harmonic Distortion	
Mic input to Group output 20Hz to 20 kHz at +15dBu	<0.01%
Noise (22Hz to 22kHz)	
Mic EIN	-129 dBu
Mix Bus Output Noise (20 ch routed)	- 80 dBu
Aux Bus Output Noise (20 ch routed)	- 80 dBu
Crosstalk (Measured at 1kHz)	
Channel Mute	>102 dB
Channel Fader Attenuation	> 96 dB
Channel Routing	> 85 dB
Channel Aux Send Attenuation	> 93 dB
Input/Output Impedances	
Mic Input	4kΩ balanced
Line Input	>10kΩ balanced
Outputs	140Ω balanced
Input/Output Levels (0VU = +4 dBu, 1.23V RMS)	
Mic Input Sensitivity	+ 4 to -62 dBu
Line Input Sensitivity	+ 12 to -38 dBu
Input Insertion Point Level	+ 4 dBu
Output Insertion Point Level	- 2 dBu
Nominal Output Level	+ 4 dBu
Maximum Balanced Output Level	+28 dBu

Configurations

GT Consoles are available in the following configurations:

Four Subgroup	16, 24, 32, 36, 44, or 56 inputs
Eight Subgroup	12, 20, 28, 32, 40, or 52 inputs
Optional stereo input modules and matrix modules are available.	

Architect's & Engineer's Specifications - GT Console

The following text should be used when specifying a Century GT in a bid or proposal.

The live sound console shall be constructed in a modular fashion and be housed in a steel frame with molded plastic side panel/carrying handles. The console shall be black with white labeling and utilize XLR lighting device connectors. The console shall have an XLR talkback mic connector and a headphone jack. These shall be located beneath the far right side of the armrest.

All microphone inputs shall be electronically balanced and accessed via 3-pin XLR connectors and have an EIN of -129 dBm. All line inputs shall be electronically balanced and accessed via 1/4" TRS jacks. The insert points shall be via 1/4" TRS jacks.

Each input channel shall have: a +48 volt phantom power switch, a -15 dB mic pad switch, a 80Hz high pass filter switch, a polarity reverse switch and 4-band (LF-40-800Hz, LMF-100Hz-2kHz, HMF-400Hz-8kHz, HF-1.5k-20kHz) sweepable EQ with peak/shelve switches on the high and low controls and an EQ In switch. Each input channel shall also have: a FET controlled (10 millisecond ramp) mute switch with LED, sub-group assignment switches, a L/R assignment switch, a dedicated mono assignment switch, a dynamic signal present LED and peak LED, a PFL switch, 4 scene mute switches (A-D), scene mute safe switch with LED, and a 100mm long throw fader.

Each input channel shall have eight auxiliary sends which shall be controlled via six knobs and four switches. The aux sends shall have a pre/post fader switch for every four sends. The aux sends shall be selectable pre or post EQ and pre or post mute. There shall be an Aux 8 direct switch that shall allow the Aux 8 rotary knob to directly control the output of the 1/4" direct out TRS jack.

The console shall be available in four or eight bus configurations. Each group module shall have a ten-segment LED meter array. The effect return section of each group module shall have a gain control, a two-band fixed EQ, sub-group assignment switches, a L/R assignment switch, a dedicated mono assignment switch, two aux send controls, a pan control, a level control, a dynamic signal present LED and peak LED, and a PFL switch. The remainder of the group module shall have a pan control, an FET controlled (10 millisecond ramp) mute switch with LED, assignment switches for: mono, L/R, Group XLR and matrix post. It shall also have a fader reverse switch with LED. A PFL switch, dynamic signal present LED and peak LED, 4 scene mute switches (A-D), scene mute safe switch with LED, and a 100mm long throw fader shall also be provided on the group module.

The master section shall be four modules in width and have the following features: an 11x2 matrix, eight aux master controls with associated AFL switches, eight aux scene mute switches with LED, a 100mm long throw fader for each of the three master outputs, a fully assignable comprehensive talkback system, a talkback mic connection, a headphone jack, stereo program input control, and five scene mute master switches each with LED.

The power supply shall be housed in a 14 ga. steel chassis that shall occupy two 19" rack spaces. The power supply shall have the ability to be daisy-chained to additional power supplies to provide a fail-safe operating environment. Connection of two or more power supplies shall not require additional interface hardware other than the provided cable.

The live sound console shall be: the Crest Audio Century GT.

GT / TC / SP Block Diagram

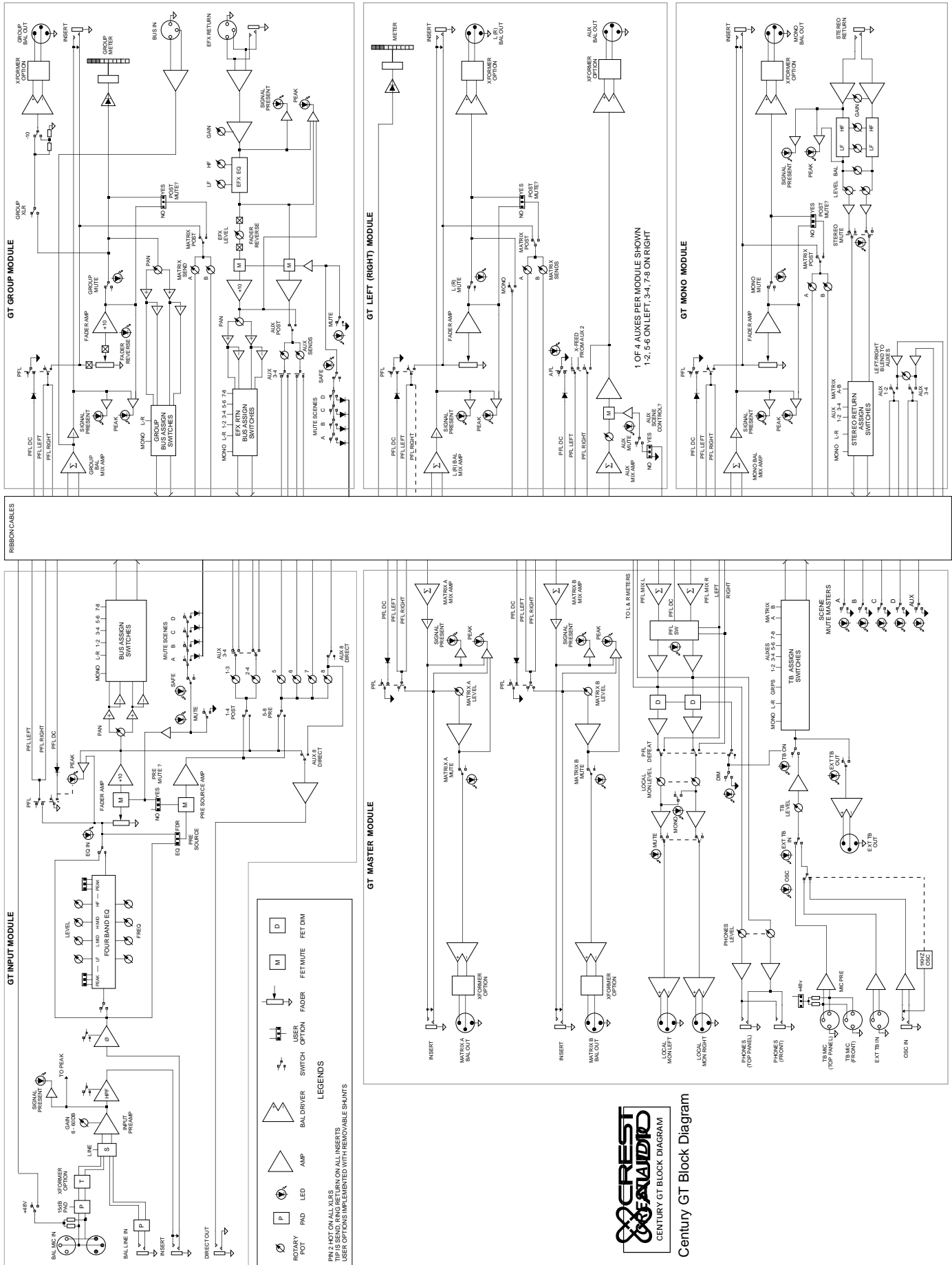

Side Dimensions

The following diagram illustrates the depth and height dimensions (from the side) for all Century SP / TC / GT consoles.

All information per
Crest Consoles Engineering,
May 5, 1997

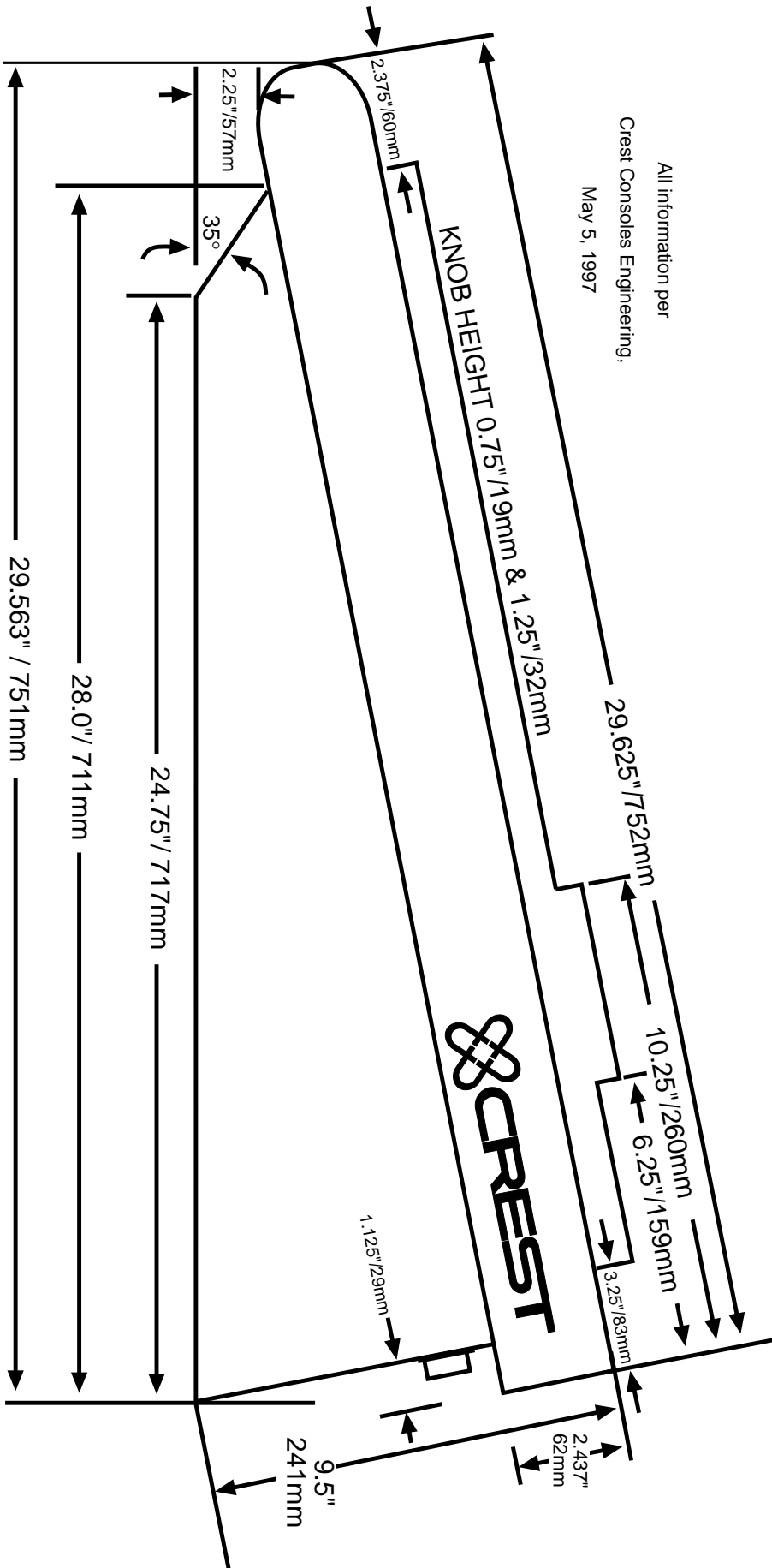

Rear Views & Dimensions

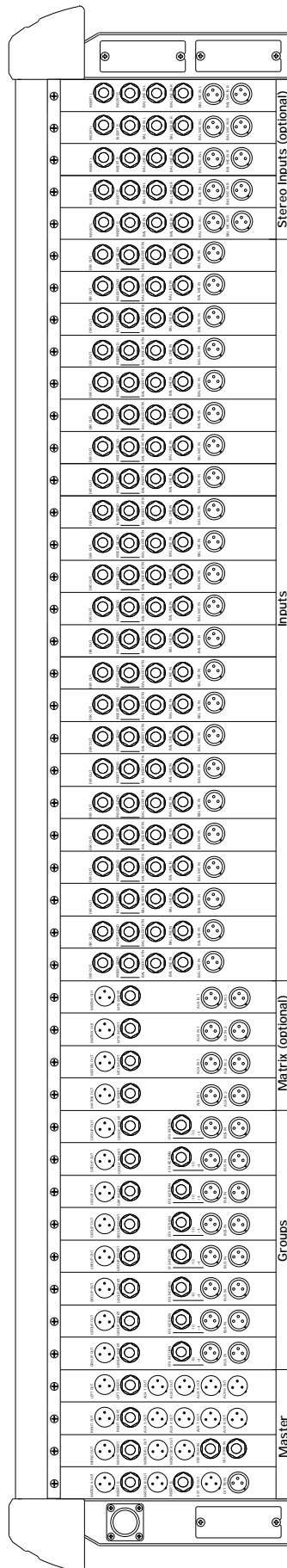

GT rear view shown

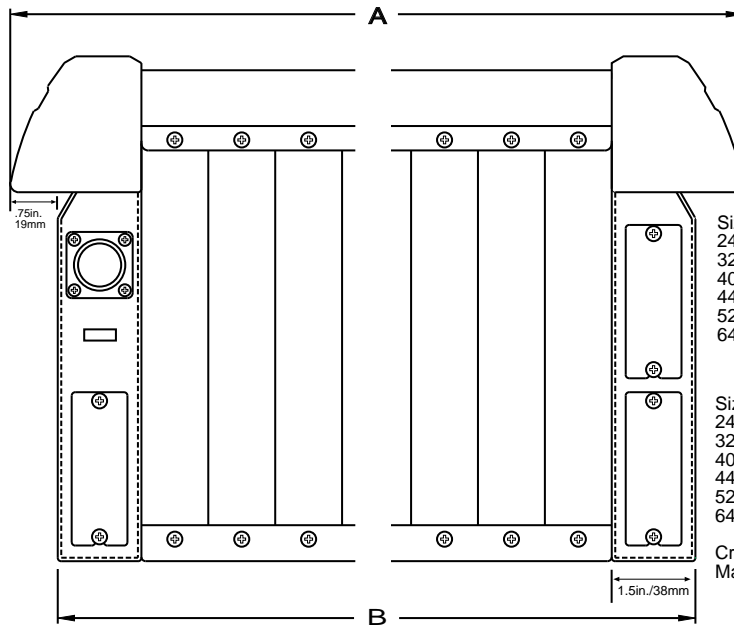

Size	A	B
24	33.55"	31.80"
32	43.15"	41.40"
40	52.75"	51.00"
44	57.55"	55.80"
52	67.15"	65.40"
64	81.55"	79.80"

Size	A	B
24	852mm	808mm
32	1096mm	1052mm
40	1340mm	1295mm
44	1462mm	1417mm
52	1706mm	1661mm
64	2071mm	2027mm

Crest Consoles Engineering,
May 5, 1997

SP/TC/GT USER-OPTIONS

SP, TC, and GT consoles are shipped having standard configuration unless specified at time of order. These are ways that the console configuration may be varied after manufacture. The items listed are internal options selected by gold jumper links.

Default is marked with a line on the board and is usually pins 1&2 of the three pin header.

In addition there are links for module function assignment. Take care to not disturb these when using USER OPTION links.

<u>MODULE</u>	<u>LOCATION</u>	<u>OPTION TITLE</u>	<u>FUNCTION</u>
	M = Main board C = Connector		Shipped with the option underlined
All Inputs	M	Pre Source (SRC)Mute	Aux sends <u>with</u> or without Mute
	M	Pre Source Select	Pre & <u>Post</u> EQ
Group Outs	M	Matrix Post Mute? Y/N	Send Group Post Mute <u>Y</u> /N
Left/Right Outs	M	J8, Aux local Mute	Fit links to enable local mutes
Monitor Master	C	Talkback XLR +48V	<u>On</u> or Off
Optional Modules			
Matrix Module	M	Cue (PFL switch)	<u>PFL</u> or AFL
GT Stereo In	M	Polarity Reverse	L only or <u>L+R</u>
	M	Aux 5-6 Select	Mono sum Pre or <u>Post</u> Fader
	M	Aux 7-8 Select	Mono sum Pre or <u>Post</u> Fader
	M	SEL 1 Pre source L	Pre EQ or <u>Pre Fader</u>
	M	SEL 2 Pre source R	Pre EQ or <u>Pre Fader</u>
	M	Pre SRC (source) Mute?	<u>Yes</u> or No



IMPORTANT



Output modules are pre-assigned at the Crest factory

These modules must always be installed in the correct positions. They are NOT interchangeable without being properly re-assigned. Please contact the Crest Audio Service Department for more information.

SP TC GT

Appendix B

Glossary

GLOSSARY

The following glossary explains the features and functions found on Century Series front of house consoles.

80Hz High Pass Switch

When depressed, this switch attenuates all low frequency content at a 12db per octave rate referenced to 80Hz. This control is useful with live microphones, as it helps reduce undesirable low frequency "rumble", usually is transmitted to the microphone by way of its microphone stand. High quality microphones employ internal shock mounts which lessen this problem, but it still remains to some degree. If this material is not removed, the low frequency content tends to make the amplifier and speaker systems work harder.

100mm Fader See Fader

48 Volt Phantom Power

This switch turns on the +48V used to power some microphones. See *XLR Microphone Input* for more information.

Auxiliary 3•4 Switch

This switch toggles the two upper Aux Send controls between 1,2 and 3,4. With the switch up, the two Send controls feed Aux 1 and 2. With the switch down, the two controls feed Aux 3 and 4.

Auxiliary 8 Direct Switch

This switch disconnects the Aux 8 level control from the Aux 8 mix bus and instead is used to control the Direct Output of the channel. Normally the Direct Out jack is post-fader. When the Aux 8 Direct switch is depressed the Aux 8 level control assumes output control of the direct out signal. The Aux 8 control is fed pre-fader.

Auxiliary Bus

The Aux Bus carries signal from the Aux Send controls to the Aux outputs on the rear panel of the Master Section. A typical setup would entail using the Aux 1-4 sends for monitor mixes while Aux 5-8 are used for effect sends. If a separate monitor mixer were being used, Auxes 1-4 could be used for additional effect sends. Effects can be returned via the EFX Return section of the group modules or through spare input modules.

Auxiliary Mute Switches

The Master Section of the GT consoles have mute switches for each Aux send. When depressed, this switch mutes the corresponding Aux Send Master. When the mute is engaged no signal leaves the associated Aux out jack and a red LED illuminates to the left of the switch. These mute switches are active only if the Aux Mute Master switch on the Master Module is depressed.

Auxiliary Pre/Post Switch

See Pre/Post Fader Switches

Auxiliary Send Controls

All Century Series consoles employ eight Aux Sends per input channel which send signal to the Aux Bus. These sends are controlled via the six level controls on each input module. Aux Sends 1-4 (orange) are typically used for monitor sends. These are the two switchable Auxes; see *AUXILIARY 3•4 SWITCH* for more info on toggling between 1,2 and 3,4. Aux Sends 5-8

(green) are typically used for effect sends. Each effect return section has Aux 1-4 Send controls, which could be used for adding effect return signal to the monitor mix. Internal jumpers select between pre/post EQ.

Bus Assignment Switches

Wherever these switches occur, they assign the post Pan pot signals to odd and even mix buses. The Pan pot controls assignment between odd and even mix buses with extreme left assigning signal exclusively to the odd mix bus and extreme right the even mix bus. It is a common practice to assign all effect return channels to a sub group channel. This enables the overall amount of effect signal to be controlled from a single fader location. Between musical numbers, it is possible to turn off the effects with this group fader or group mute switch or to vary the amount of overall effect return in reference to the dry original signals, using the group fader control.

DC Power Indicators

Each Century Series console uses a variety of electrical voltages which are fed to the console from the power supply. The status of each operating voltage (+20, -20, +48, +24) is indicated by four LED's on the master module. If the console ever behaves abnormally, first check these LED's to make sure that the power supply is providing the proper voltages.

Dim Switch

This GT Master Section switch produces a -12dB attenuation in signal to the local monitor. This feature is useful for temporary lowering of local monitor levels without actually adjusting any pots or faders. (Local monitors are automatically dimmed when Talkback button is pressed.)

Direct Out Jack

Each input module has an unbalanced 1/4 direct out jack. The output from this jack is post-fader unless the *AUXILIARY 8 DIRECT* switch is depressed. When this switch is down the output is controlled by the Aux 8 pot. See *AUXILIARY 8 DIRECT* for more information on that switch.

Effect Auxiliary Level Control

See *AUXILIARY SEND CONTROL*

Effect Return EQ

Each effect return section has a two-band fixed EQ. These High and Low frequency controls are centered at 10kHz and 80Hz respectively.

Effect Return Gain

This control adjusts the gain on the signal returning from the effect. Use the effect return signal present and peak LED's to set the gain properly.

Effect Return Subgroup Assignments

Much like the switches on each input module, these switches assign the corresponding effect return to any or all subgroups. The Pan control operates in the same fashion, that is; extreme left assigning signal exclusively to the odd mix bus and extreme right the even mix bus.

EQ In Switch

This input module switch, when depressed, inserts the EQ section into the signal path and illuminates a green LED to the left

of the switch. With the switch in the up position, the input signal bypasses the EQ section and continues unmodified.

EQ Sections

These controls are used to modify the tonal quality of an audio signal. All Century Series consoles have a four-band EQ section on each input module. The effect return sections, within the group modules, have two-band EQ sections. Within an input module, the EQ section will affect the signal only if the EQ IN button is depressed.

EQ Control knobs - Fixed EQ:

When there is only one knob, it controls the boost or cut of a fixed frequency range. The SP input modules and all effect return sections have these single knob/fixed EQ controls.

EQ Control knobs - Sweep EQ:

When there are two knobs, the inner knob controls the boost or cut as in the fixed EQ, while the outer knob controls the center frequency adjusted by the inner knob. These center frequencies are printed on the module around the outer knob. The GT input module has the frequency sweep knobs on all four bands, while the TC input module has them only on the mid-frequencies.

EQ Sweep Control

See *EQ SECTIONS*

External Talkback Input Switch

This switch disconnects the two regular talkback microphone inputs and switches on the external talkback input XLR found on the rear panel of the GT master section.

External Talkback Output Switch

This switch activates the external talkback output XLR. The signal fed to the connector is the same signal being sent to the talkback assignments.

Fader

The fader is used for primary level control of the channel, except those Aux output sections selected to a pre-fader position. (The Insert output level is not affected by the fader position.)

Optimum noise performance is achieved when the fader is operated near the 0 fader position and all gain controls are properly set. This does not mean that all channels should be set at 0. Proper mixing requires varying of at least some of the faders. The 0 point should be considered a reference, with all volume changes taking place between the -10 and 0 reference points at normal desired levels. For effect, faders may be operated below this level, provided no faders within the group or master section are increased in level to compensate for the input's lower fader setting.

Fader Reverse Switch

This switch swaps roles between the Effect Return Level pot and the Subgroup Fader. When depressed, this switch causes the Effect Return Level to be controlled by the Subgroup fader, and the Subgroup level to be controlled by the Effect Return Level pot. If you want the control of the fader when setting effect returns, this switch is particularly helpful. A red LED indicator is provided to the left of the switch and illuminated when the switch is depressed (reverse mode).

Gain Control

This knob adjusts input gain circuitry for proper electrical operation. Adjust this control by monitoring signal present (green) LED for bright intensity, with peak (red) LED flashing only occasionally when the loudest program material is present. When a PFL switch is depressed on an input channel, this signal can be observed on the Left/Right monitor meters within master module. When using this method for adjustment of the Gain Control, normal signal level should be adjusted to show a level between -9 VU and 0 VU. Constant distortion on an input channel could mean that the input channel is being overdriven. Check for improper input gain adjustment first.

Group Assignments

See *BUS ASSIGNMENT SWITCHES*

Group Meter

Located at the top of each subgroup module, this ten-segment LED meter monitors the post-fader output of the group. Similar meters on the Master Section monitor Left and Right outputs.

Group XLR Switch

This switch assigns the post fader group signal to the group out XLR located on the rear panel of the group module.

Headphone Jacks

Located at the top of the master section and under the right side of the hand rest, these jacks provide a pre-fader stereo headphone level output of the Left and Right outputs. When anything on the console is PFL'd or AFL'd, the R+L output is replaced by whatever is PFL'd/AFL'd.

Headphone Level Control

This control adjusts the level of the signal fed to the two headphone jacks; located in the upper right portion of the master section, just below arm rest on the far right side.

HF Peak/Shelve Switch

This switch is used for switching the high frequency EQ control between the normal shelving setting to a peak setting.

High Pass Switch

See *80Hz HIGH PASS SWITCH*

HMF EQ Control

See *EQ SECTIONS*

Insert Jack

This jack allows you to access a point in the channel's electrical circuit for inserting an external signal processor. The output level of this connector is designed to drive the inputs of most external signal processing equipment and to accept the resulting output signal. When a properly wired TRS plug is inserted in this jack, the input signal path is broken after the gain stage and high pass filter. The return signal is fed to a point just before the EQ section. See the *Connections and Conventions* section in the front of the manual for specific information on plug polarity and signal assignments. (This jack could be used to connect an effect with an unbalanced 1/4" connector; however, the signal path would be broken, leaving the remainder of the input module unused, and the effected signal would need to be returned to the console via an unused input channel. A

stereo (TRS) plug can be used with the Tip & Ring tied together to access the channel signal pre-EQ).

Internal Oscillator

The GT master section has a 1 kHz internal oscillator. This oscillator can be used as signal source to run tests, diagnostics or calibrations. The oscillator can be assigned to all Groups, Auxes and Matrices via the Talkback assignment switches.

Lamp Dim Control

This control adjusts the brightness of whatever lighting devices are plugged into the XLR sockets on the light bar.

Left Meter

This ten segment LED meter normally displays the signal level of the Left output. If any signal is in PFL mode, then this meter displays that signal instead.

LF Peak/Shelve Switch

This switch is used for switching the low frequency EQ control between the normal shelving setting to a peak setting.

Line Input Jack

This is a balanced, high impedance input which is designed to accept both balanced and unbalanced line level inputs. To select this input source, press the front panel LINE switch. See the Connections and Conventions section in the front of the manual for specific information on plug polarity and signal assignments.

Line Switch

This switch, when depressed, selects the balanced Line Input as opposed to the default balanced XLR Mic input.

Local Monitor Level Control

This control adjusts the level of the signal to the Local Monitor Outputs on the back of the Master Section.

Matrix Level Control

These controls adjust the amount of group, L/R or Mono signal fed to the respective matrix.

Matrix Master Control

These controls adjust the final signal level for the associated matrix output.

Matrix Pre/Post Switch

This switch switches the group, L/R or Mono matrix send between pre and post fader.

Mono Bus Assign Switch

Assigns the input signal directly to the Mono Clean bus. This signal is unaffected by the position of the Pan Control, but is controlled by the level position of the fader. Signal may be assigned to this bus when you wish to assign this input signal to the Mono output without going through the Stereo section of the mixer. In addition to the many mono output uses, this output can be used as an additional Effect Send.

Mute Switch

Turns off all send functions (except insert send) of the module including those being used as monitors. (Monitor Mute may be defeated internally - See your service facility for further information.) This switch does not affect the PFL switch or the Peak and Signal Present LED indicators, enabling monitoring

of input channel activity regardless of mute switch position. The LED illuminates when the channel is muted, either from the local mute switch or from any activated mute group.

Switch

See *POLARITY REVERSE SWITCH*

PAD Switch

This -15dB pad attenuates the signal presented to the first stage of the input module. It is important to note that the Pad Switch acts only upon the balanced XLR input signal; it has no effect upon the 1/4" input signal. The input GAIN control should be positioned somewhere within its center 80% of travel. In the event that the Gain control is set in its lower 10% of travel, and the Peak LED is indicating more than an occasional short illumination, the PAD Switch should be depressed and the Gain re-adjusted as above. In the case where the GAIN control is set to its upper range of travel (3 o'clock position or above) with the PAD switch depressed, the Gain Control should initially be lowered and the PAD switch released. The gain should then be increased and adjusted as above.

Pan Control

When operating a stereo sound system or recording, this control positions the image anywhere within the stereo spectrum when the Left/Right assignment switch is depressed. When signal is being sent to a subgroup, the pan control acts as part of the assignment system. Full counter clockwise assigns signal to the odd numbered mix bus and full clockwise assigns the signal to the even numbered mix bus. Subgroups may also be used as stereo pairs in which case this control functions the same as when assigned to the Left/Right bus.

When the pan is in its center position, signal is fed equally to the odd (left) and even (right) mix buses. When used in stereo applications, the channel signal may be located anywhere within the stereo image as controlled by the Pan control.

PEAK LED Indicator

Illuminates RED when any of the points monitored come within 3db of its clipping point. Occasional quick blinking of this LED is normal under proper operation; when this LED illuminates noticeably, a correction should be made in the level control feeding that position to a point where this illumination is reduced to the normal occasional flashing. It should be noted that certain musical instruments produce very high levels of peak response that are far above the average output levels of these instruments. These include portions of any drum kit, but most notably the bass drum and snare drum. It is considered almost normal practice on these instruments to set the input gain control to a point when the Red Peak LED is just firing with nearly every hit of the drum.

This LED also serves as a PFL ON indicator, but at a much lower intensity than when it is used to indicate a near overload condition.

PFL Switch

The PFL (Pre Fader Listen) switch enables the operator to listen to the channel signal before the fader or main channel level control, allowing for monitoring within the master section of the console. This signal IS NOT affected by the Channel Mute Switch. When this switch is depressed, the signal level can be

seen on the Left/Right/Monitor meters, and can be heard both in the mixer's headphone output and on the rear panel monitor output of the console. When the PFL Switch is depressed, the channel PEAK LED indicator illuminates at a low intensity. When used as an indicator of switch position, the Peak LED indicating circuit remains fully operational by illuminating at a much higher intensity than its use as a status indicator.

Phantom Power

See *48V PHANTOM POWER*

Polarity Reverse Switch

This switch is used on input channels to adjust between dissimilar microphone output polarity (see your microphone's instruction manual). It is also used to adjust phase cancellation between microphones when more than one microphone is picking up the same acoustical signal (This should be kept to a minimum with proper microphone placement).

Pre/Post Fader Switch

Switches the Aux signal sources between pre-fader and post-fader positions. The pre-fader position is usually used for monitor sends, so that any movement of fader level does not affect these outputs. This is desirable for monitors, since their levels normally need to be operated independently of the main (front-of-house) system. When in the post-fader position, signal output level from the Aux sends will proportionally follow the main signal level. The result is maintenance of an effect in proportion to the main signal level. When an input signal is faded to 0dB, the post-fader Aux Send signals are also decreased to 0dB. In some cases, it may be desirable to derive effect sends pre-fader for special effects, such as those generated by a vocal doubler or harmonizer. The choice of switch position should be determined by the actual situation; though as a general rule, choose the pre-fader position for monitor sends and post-fader position for effect sends.

Right Meter

This ten segment LED meter normally displays the signal level of the Right output. If any signal is in PFL or AFL mode, then this meter displays that signal instead.

Scene Mute Assignment Switch

Found on GT input and group modules, these switches assign the input or EFX Return signal to one or more of the scene mutes. These mutes are activated via the scene mute master switches found on the master section.

Scene Mute Master Switches

Found on the GT Master Section, these switches activate the four scene mutes.

Scene Mute Safe Switch w/LED

This switch, found beneath the Scene Mute Assignment Switches, disables any selected scene mutes. A green LED indicates that the Safe switch has been engaged.

Signal Present LED

This LED displays, in real time, the level activity of the channel by varying the intensity. Any illumination of this LED indicates that a signal is present and is somewhere within the usable operating level. Optimum operation is when this LED is at a bright but varying intensity and following the channel's

signal levels, with just an occasional short flash of the red peak LED indicator.

Sweep Control See EQ SECTIONS Talkback Assignment Switches

These switches assign the talkback signal to the outputs and/or auxes.

Talkback Level Control

This knob controls the final level of the talkback signal, and dims local monitor output, if Dim switch has not been pressed.

Talkback Microphone Input

Found on the master section (GT) and under the arm rest on the right side, these balanced XLR inputs allow for a microphone or other balanced mic-level source to be connected to the talkback system.

Talkback On Switch

This switch activates the entire talkback system including the internal oscillator.

XLR Balanced Outputs

This output is designed to drive both balanced and unbalanced input devices without adaptation. Signals are normally balanced on this output connector. The output is designed so that if either pin 2 or pin 3 were intentionally shorted (as in connecting to an unbalanced input of your next stage of electronics) or accidentally shorted, the output level of the non-shortened connector pin increases by 6db. This is an amount equal to the normal loss of a balanced output when one pin of a balanced output is shorted. The result is no need for external gain make up.

XLR Microphone Input Connector

Balanced XLR Input is designed to receive professional Low Impedance microphone signals. The input Gain controls on the front panel adjusts for most input levels. In the event of excessive input levels, the front panel input pad switch should be depressed. Front panel selection of 48 Volt Phantom power enables most types of condenser microphones that require such power to be used. (Note: most input devices can tolerate 48 Volt phantom power to be placed on their output terminals (provided they are truly balanced) without causing damage to the device. See your device's operating manual for correct operation. (If in doubt as to whether your non-condenser microphone may be damaged by using Phantom Power, please make sure that the front panel phantom power switch on that input channel is in the off [out] position.)

This input may also be used for low level line input signals, provided the source (instrument) is able to drive a 5k Ohm or higher load. (See your instruments or electronics owner's manual for output impedance.) When line output devices such as tape players are plugged into the microphone input, special care should be observed that the phantom power is turned off on that channel, as damage may result. Because of this, it is recommended that the 1/4" line input connector be used when connecting a line level device. 48 Volt Phantom power is not present on these input connectors, and the impedance of the line input connector is high enough to accept any line level device.

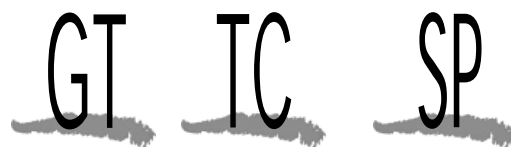

Appendix C - Schematics

<u>LOCATION</u>	<u>DESCRIPTION</u>	<u>SCHEMATIC #</u>	<u>DWG #</u>	<u>REV #</u>	
STANDARD INPUT MODULE	INPUT CONNECTOR PCB	1		N/A	04
GT INPUT MAIN PCB		2		76D1530	04
TC INPUT MAIN PCB		3		N/A	02
SP INPUT MAIN PCB		4		N/A	02
STEREO INPUT MODULE	STEREO INPUT CONNECTOR	5		76D1920	02
STEREO INPUT MAIN PCB (1 OF 2)		6		76D1919	01
STEREO INPUT MAIN PCB (2 OF 2)		7		76D1919	01
GROUP MODULE	GROUP CONNECTOR PCB	8		N/A	01
GROUP MAIN PCB		9		N/A	03
LEFT / RIGHT OUTPUT MODULE	LEFT / RIGHT CONNECTOR PCB	10		N/A	01
L/R MAIN PCB		11		N/A	04
MONO OUTPUT MODULE	MONO CONNECTOR PCB	12		N/A	04
MONO MAIN PCB		13		N/A	03
MASTER CONTROL MODULE	MASTER CONNECTOR PCB	14		N/A	04
MASTER MAIN PCB		15		N/A	04
MATRIX MODULE	MATRIX CONNECTOR PCB	16		76D1922	02
MATRIX MAIN PCB		17		76D1921	01
RIBBON CABLE PIN OUT DIAGRAMS	RIBBON PIN OUTS	18			



Crest Audio Inc.

100 Eisenhower Dr., Paramus NJ 07652 USA

TEL: 201.909.8700 FAX: 201.909.8744

<http://www.crestaudio.com>

Printed in USA

SP/TC/GT Owners Manual
Copyright © 1997 Crest Audio Inc.
v. 2.2 11/3/97 - D7000001



D7000001